

DL210

Data Logger DL210

Operating Manual and Installation Instructions

Operating Manual: 73018816 SW version: from V1.00
Issued 18.09.2006 (a) Edition:

All rights reserved.

Copyright © 2006 Elster-Instromet GmbH, D-55252 Mainz-Kastel

All details and descriptions in this operating manual and installation instructions have been given only after careful checking. Despite this however, the possibility of errors cannot be completely eliminated. Therefore, no guarantee can be given for completeness or for the content. Also, the manual cannot be taken as giving assurance with regard to product characteristics. Furthermore, characteristics are also described in it that are only available as options.

The right is reserved to make changes in the course of technical development. We would be very grateful for suggestions for improvement and notification of any errors, etc.

With regard to extended product liability the data and material characteristics given should only be taken as guide values and must always be individually checked and corrected where applicable. This particularly applies where safety aspects must be taken into account.

The guarantee becomes invalid if the product described here is not handled properly, repaired or modified by unauthorised persons or if replacement parts which are not genuine parts from Elster-Instromet GmbH are used.

You can obtain further support from the branch or representative responsible for your area. You will find the address in the Internet or simply enquire at Elster-Instromet GmbH.

Passing this manual to third parties and its duplication, in full or in part, are only allowed with written permission from Elster-Instromet GmbH.

Mainz-Kastel, September 2006

Contents

Part 1	11
1 Brief description	12
1.1 Functions and performance features.....	12
2 Operation	15
2.1 Front panel.....	15
2.2 Display.....	16
2.2.1 Line 1 = Labels	16
2.2.2 Line 2 = Value with name and unit.....	18
2.3 Operation.....	18
2.3.1 Movement within the list structure.....	18
2.3.2 Meaning of the keypad.....	19
2.4 Formation of the list structure	20
2.4.1 Summary charts, List Structure (1)	20
2.4.2 Summary charts, List Structure (2)	21
2.4.3 Summary charts, List Structure (3)	22
2.4.4 Summary charts, List Structure (4)	23
2.4.5 Summary charts, Submenus "U1" to "U9"	24
2.5 Changing values.....	25
2.5.1 Differentiating between values (data classes).....	25
2.5.2 Entry function.....	26
2.5.3 Entry errors	27
2.5.4 Example of changing values	28
2.6 Securing the values (access rights).....	30
2.6.1 Calibration lock and calibration switch	30
2.6.2 Access lock "PTB logbook"	30
2.6.3 Supplier and customer locks.....	31
2.6.4 Opening, changing and closing the supplier's lock	31
2.6.5 Opening, changing and closing the customer's lock	34
3 Functional description	35
3.1 List structure for Input 1 and Input 2.....	35
3.1.1 Input 1 set as counting input.....	35
3.1.2 Input 1 set as encoder input.....	36
3.1.3 Input 1 set as signal input	37
3.1.4 Input 2 is signalling input (unmodifiable)	37
3.1.5 Description of the values.....	37
3.1.6 Submenu encoder data.....	42
3.2 Archives in the DL210	44
3.2.1 Values common in all archives	45
3.2.2 Structure of the month archive Input 1	46
3.2.3 Structure of meas. period and day value archives Input 1	48
3.2.4 Measurement period and memory depth	49
3.2.5 Application as flow recording device.....	49
3.2.6 Application as high flow display device.....	51

3.2.7	System interface.....	52
3.2.8	Reading out archives.....	54
3.3	Status list	57
3.3.1	Description of the values	57
3.3.2	Submenu: Status register	58
3.3.3	Submenu: Momentary status.....	58
3.3.4	Submenu: Logbook	59
3.3.5	Submenu: Changes archive (audit trail)	60
3.3.6	Submenu: PTB logbook.....	61
3.3.7	Description of values shown in the audit trail and PTB logbook	62
3.3.8	The status register.....	63
3.3.9	Summary of message numbers.....	64
3.3.10	Explanation of the messages	65
3.3.11	Determining an error message	67
3.3.12	Clearing an alarm or a warning	68
3.3.13	Events in the DL210	69
3.4	System list.....	77
3.4.1	Description of the values	77
3.5	Service list.....	79
3.5.1	Description of the values	79
3.6	Interface list.....	83
3.6.1	Description of the values	83
3.6.2	Optical interface (Interface 1)	87
3.6.3	Modem operation in the DL210 (Interface 2)	87
3.6.4	Short messages in the DL210 (SMS function).....	88
3.7	User list.....	95
4	Operation under calibration	97
4.1	Setting the parameters on site	97
4.2	Checking the set values	97
4.3	Calibration inspection.....	97
4.4	Sealing.....	98
4.5	Seal layout	99
4.6	Recalibration of the DL210.....	100
Part 2	101
5	Installation	102
5.1	Mounting options.....	103
5.2	Antenna options	104
5.2.1	Option: External antenna.....	104
5.2.2	Option: Housing for GSM antenna	104
5.3	Installation procedure.....	105
5.3.1	Mounting the device	105
5.3.2	Terminal layout.....	108
5.3.3	Settings for modem operation	109
5.3.4	Setting the customer-specific parameters	109
5.3.5	Functional testing	110
5.3.6	Setting for interfacing to WinVIEW & WinLIS evaluation software.....	111

5.4 Maintenance.....	112
5.4.1 Battery replacement (basic unit)	112
5.4.2 Battery replacement (modem battery).....	114
5.4.3 Battery service life.....	115
Appendix	118
Appendix A: Approvals	119
A-1 EC Declaration of Conformance for DL210	119
Appendix B: Technical data	121
B-1 General data (mechanical)	121
B-2 Power supply.....	121
B-3 Encoder, pulse and message inputs	122
B-4 Optical interface	123
B-5 Measurement uncertainty.....	123
Appendix C: Data list.....	124
Appendix D: Index.....	133

I Safety instructions

- ☞ The connections of the DL210 are freely accessible during setting up. In order to avoid damage to the components, make sure that no electrostatic discharge (ESD) can occur.
The person carrying out the installation can, for example, discharge himself/herself by touching the potential equalisation line.*
- ☞ To avoid erroneous operation and problems, the operating manual must be read before putting the DL210 into operation. In particular the descriptions in Chapter 5 should be followed.*

II Items supplied and accessories

II-1 Included items

The following items are included with the DL210:

- a) Data Logger DL210
- b) Dispatch list
- c) Design data sheet
- d) Operating Manual
- e) Bag of accessories

II-2 Ordering information and accessories

Data Logger DL210

- Complete device 834 80 070

Accessories

- GSM antenna, external 4m 730 18 956
- GSM antenna, external 10m 730 18 957
- GSM antenna housing (for ext. antenna) 730 17 320
- Top-hat rail holder 041 95 063
- Wall-mounting bracket 041 95 035
- Control panel mounting frame 041 95 064
- Universal retaining bracket for pipe mounting 730 18 057
- Operating manual, German 730 18 815
- Bag of accessories DL2xx 730 18 291
- Battery module, 16.5 Ah (for basic device) 730 15 774
- Battery module, 2.1 Ah (for mains operation) 730 16 294
- Battery module, 13 Ah (for GSM modem) 730 17 964
- IR readout head (with 6-pole Binder plug) 730 15 883
- KD-100/PS2 readout cable 730 15 152
- Interface cable for internal connection 730 17 970
- IR readout head with DSUB socket 730 17 812
- IR readout head with USB connection incl. driver CD 041 15 530

Part 1

Device description relevant to calibration

1 Brief description

1.1 Functions and performance features

General remarks:

The Data Logger DL220 is intended as a battery operated, compact device, capable of being calibrated, for the acquisition and storage of counting pulses or encoder readings as well as level changes for various types of energy:

- One counting input (I1) and one signalling input (I2) with a common ground for connection to a generator outside of the Ex area.
- Acquisition and archiving of meter readings and maxima for Input 1.
- System monitoring (signalling function) with appropriate reactions via Input 2: Entry in the measurement period archive of Input 1 and/or message via remote data transfer (SMS message) to up to two recipients.

Approvals:

- PTB approval as high-flow display device and as flow recording device for the media gas and water.

Operator interface:

- 2-line, 16-place LCD, plain-text description of the values.
- Operation via 4 cursor keys, special functions by operation of two keys.
- Programming via keypad possible.
- Access to the device via different levels possible:
Official calibration (switch in device separately sealed), manufacturer, supplier or customer.
- Selectable write and read rights for various values.

Power supply:

- External voltage supply 9 VDC – 24 VDC for relieving the device and modem battery.
- Battery operation for basic unit; service life depends on operating mode ≥ 8 years.
- Battery operation for GSM modem unit; service life depending on operating mode ≥ 4 years
- Optional: Additional battery for GSM modem
- Battery replacement possible without loss of data and without violation of calibration seals.
- Data back-up of all system data and relevant billing data (e.g. month-end readings, maxima...) without battery supply using EEPROM.

Data interface:

- Optical interface according to IEC 62056-21 (IEC 1107)
- Internal GSM or GSM/GPRS modem.

Pulse / signalling inputs:

- Input 1 programmable as pulse, signalling or encoder input (Namur, SCR) .
- Input 2 permanently configured as signalling input.
- Possible connection of reed contacts and transistor switches on both inputs.
- Maximum counting frequency in pulse operation 10 Hz.
- Calibrated counter, adjustable counter (under supplier's lock), incrementing measurement period counter and day counter separate for Input 1.

Mechanical details / housing:

- Wall-mounted housing, 122x122x91mm (WxHxD)
- Optional: External mounting feet, top-hat rail mounting or panel-mounting frame
- Mounting and device installation without breaking the calibration seals.
- Temperature range for basic unit: -20°C...+60°C;
temperature range with various options: see Appendix B-1.
- Class of protection: IP 64, non-condensing atmosphere.

Software:

- Archives
 - a) A counting channel (I1) with 11500 entries (approx. 15.5 months memory depth with 60 min. measuring period - depending on other entries).
 - b) Month-end readings as well as day and measurement period maxima of the last 15 months for Input 1.
 - c) Logbook: 250 entries
 - d) Audit trail (changes logbook): 200 entries
 - e) PTB logbook: 50 entries
 - f) Day value archive for Input 1: 500 entries
- Event controlled archiving of the meter readings.
- Backup of all system data in an EEPROM after changes.
- Automatic saving of date and all counter readings 1x per day
- Display of the archived values possible on the display incl. skip function in archive.
- Computation of measurement period value (consumption) in archive possible on-line.
- Calibrated counter and adjustable counter saved in the archives.
- Separate read-out modes for supplier, customer, maintenance and network operator (i.e. support of up to 4 independent read-out parties possible).
- Provision of a day boundary; value can be called into display.
- Display of the momentary flow.
- Measurement period of 1...60 minutes and 1...24 h.
- Display of current, last day and measurement period consumptions on display.
- Provision of a measuring point identifier according to Association Agreement.
- Also non-decade pulse values can be programmed.
- Three modes for the selection of summer/winter time (none, automatic, manual setting).

GSM mode (standard):

- Remote data transmission in freely selectable time windows.
- Auto-login at start of the four possible call windows.
- Application of TWIN cards possible through different call windows.
- Remote adjustment of all values possible depending on lock status.
- Access monitoring for readout and setting of values via locks.
- Different GSM antennas can be used depending on on-site requirements.
- PIN support for SIM card security.
- Display of network operator and reception strength.

GPRS mode (option TSC):

- All functions of the GSM operating mode.
- GPRS data link (via TAINY Switching Center, Dr. Neuhaus) possible with external voltage supply.

Sending short messages (SMS):

- Ten different brief messages via SMS to a control station with GSM modem or a mobile phone based on messages occurring in the DL210.
- Sending of an SM to up to two recipients possible.
- Up to ten different customised lists each with up to 15 values per list which can be sent via SMS (incl. abbreviated designation and unit).
- SM initiation for test purposes possible on device.

Monitoring functions

- Monitoring of signalling inputs with appropriate reactions (e.g. warning, entries in the logbook or measurement period archive, sending a short message).
- Monitoring of programmable limits.
- Internal monitoring of the HW and SW functions in the unit.

2 Operation

2.1 Front panel

For operation a two-line LCD display with 16 places per line and four cursor keys is provided on the front panel:

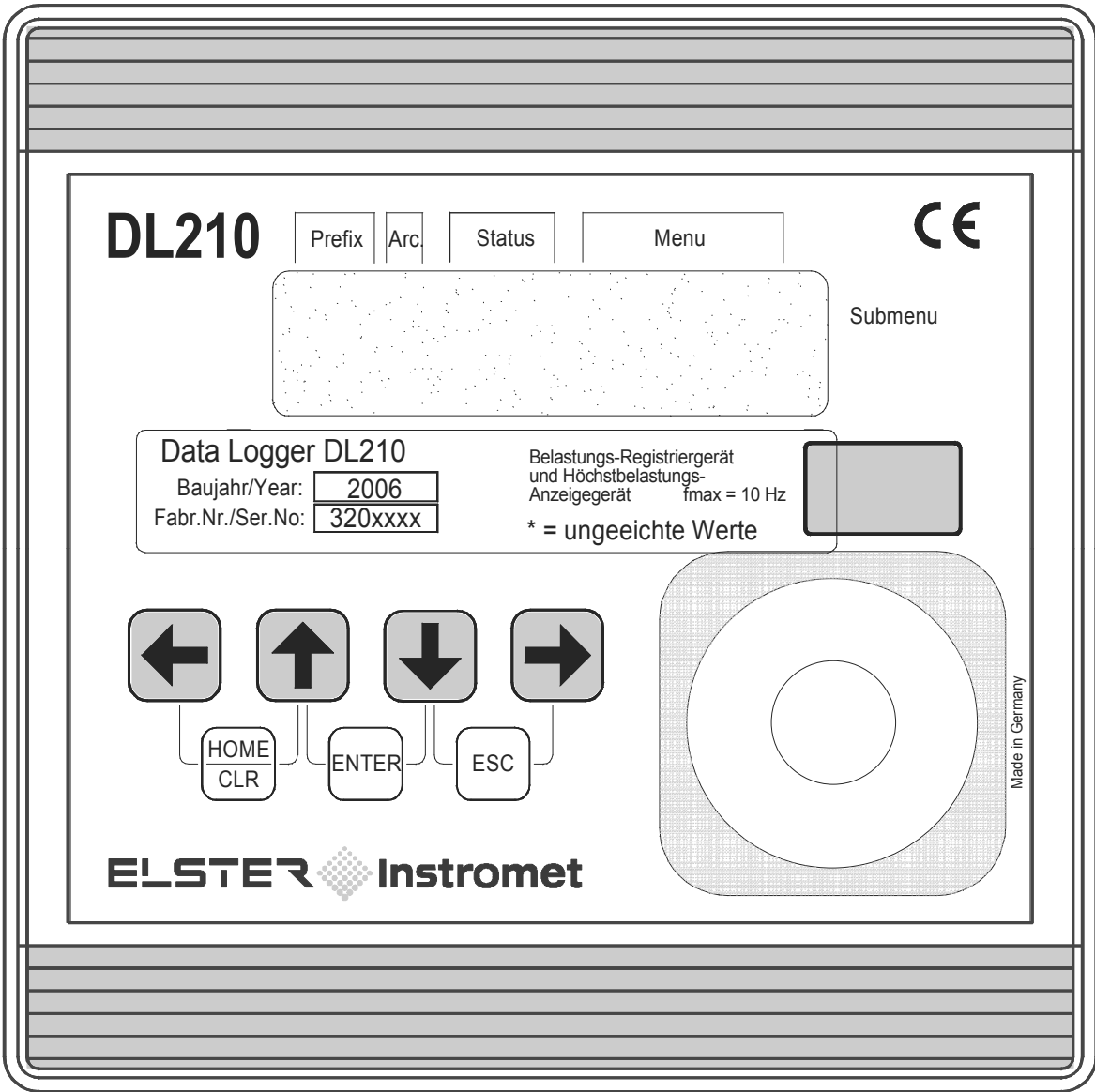

2.2 Display

Basic layout of the display:

Prefix			Archive			Device status			Menu					
m	a	x	↑	A	W	B	I	n	p	u	t	1	→	Submenu
V	b	P	1	2	3	4	5	6	7	.	8	m	3	

Both lines in the display are subdivided into fields which are described below.

2.2.1 Line 1 = Labels

The first line is subdivided into the following five fields:

1. Prefix (type of computation)

The type of computation identifies so-called "initial values" (also termed "capture values"). These are values which have been formed over a time period (e.g. the adjustable measurement period or one month). Labels:

- max Maximum – highest value within the time range
- min Minimum – lowest value within the time range
- Δ Change – volume within the time range
- ∅ Mean – mean within the time range

2. Archive

If an arrow points upwards to the label "Archive", then the displayed value is an archived value. This was frozen at a defined point in time and cannot be changed.

3. Device status

Here a maximum of three of the most important items of status information are continually shown.

A flashing character signifies that the relevant state is still present and the relevant message is present in the momentary status.

A non-flashing character signifies that the relevant state is past, but the message in the status register has not yet been cleared.

Meaning of the letters:

- **A "Alarm"**
At least one status message has occurred which is valid as an alarm. Alarm messages are copied into the status register and are retained here, even after rectification of the cause of the error, until they are manually cleared.
- **W "Warning"**
At least one status message has occurred which is valid as a warning. Warning messages are copied into the status register and are retained here, even after rectification of the cause of the error, until they are manually cleared.
- **B "Battery low"**
The remaining battery service life is less than 3 months.
- **P "Programming mode"**
The programming lock (calibration lock) is open.
- **L "PTB logbook"**
The PTB logbook (calibration logbook) is full. Modification of the parameters which are taken into account in the PTB logbook are only possible with the programming lock (calibration lock) open.
- **o "online"**
A data transmission is running via OPTO- or modem communication. The other interface cannot then be used during this period.

☞ ***The calibration lock can only be closed when the PTB logbook is not full!***

4. Menu

Here is displayed to which list according to Chapter 2.4 the currently displayed value belongs. In submenus (indicated by an arrow to the left, see below) its name is displayed which is identical to the abbreviated designation of the entry point.

5. Submenu

- → (Arrow to the right)
indicates that the displayed value is the entry point of a submenu. This can be called with the key [ENTER].
- ← (Arrow to the left)
indicates that you are located in a submenu which can be quit with the key [ESC]. On pressing [ESC] you are returned to the entry point of the submenu.

2.2.2 Line 2 = Value with name and unit

In the second line the name, value and (when available) the unit of the data are always shown.

Uncalibrated values are identified for the user with an asterisk ("*") after the abbreviated designation.

For use outside of applications involving calibration, the unit can also be obtained without the identification of uncalibrated values.

Example of uncalibrated values:





V	1	A	*	1	2	3	4	5	6	7	.	8	m	3
---	---	---	---	---	---	---	---	---	---	---	---	---	---	---

Example of calibrated values:

V	1			1	2	3	4	5	6	7	.	8	m	3
---	---	--	--	---	---	---	---	---	---	---	---	---	---	---

2.3 Operation

2.3.1 Movement within the list structure

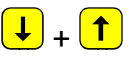
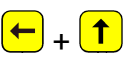
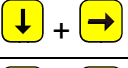
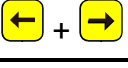
Key(s)	Description	Action
	Arrow key, up	Upwards movement within the current list: From the first value in the list movement is then to the last value.
	Arrow key, down	Downwards movement within the current list: From the end of the list movement is then to the first value.
	Arrow key, left	Skip from any value within a table to the top value of the column to the left . ¹
	Arrow key, right	Skip from any value within a table to the top value of the column to the right . ¹
	ENTER	Activate entry mode, open submenu or update measurements.
	HOME/CLR	Skip to the first element of the list structure or to the latest entry in an archive.
	ESC	Skip from a submenu to the menu immediately above.
	HELP	Calls the address of the displayed value.

¹ With similar lists skipping occurs to the similar value in the adjacent list.

2.3.2 Meaning of the keypad

The meaning of the keypad depends on whether only values are being recalled (operation – highlighted in colour) or whether the DL210 is located in the input mode (shown in italics):

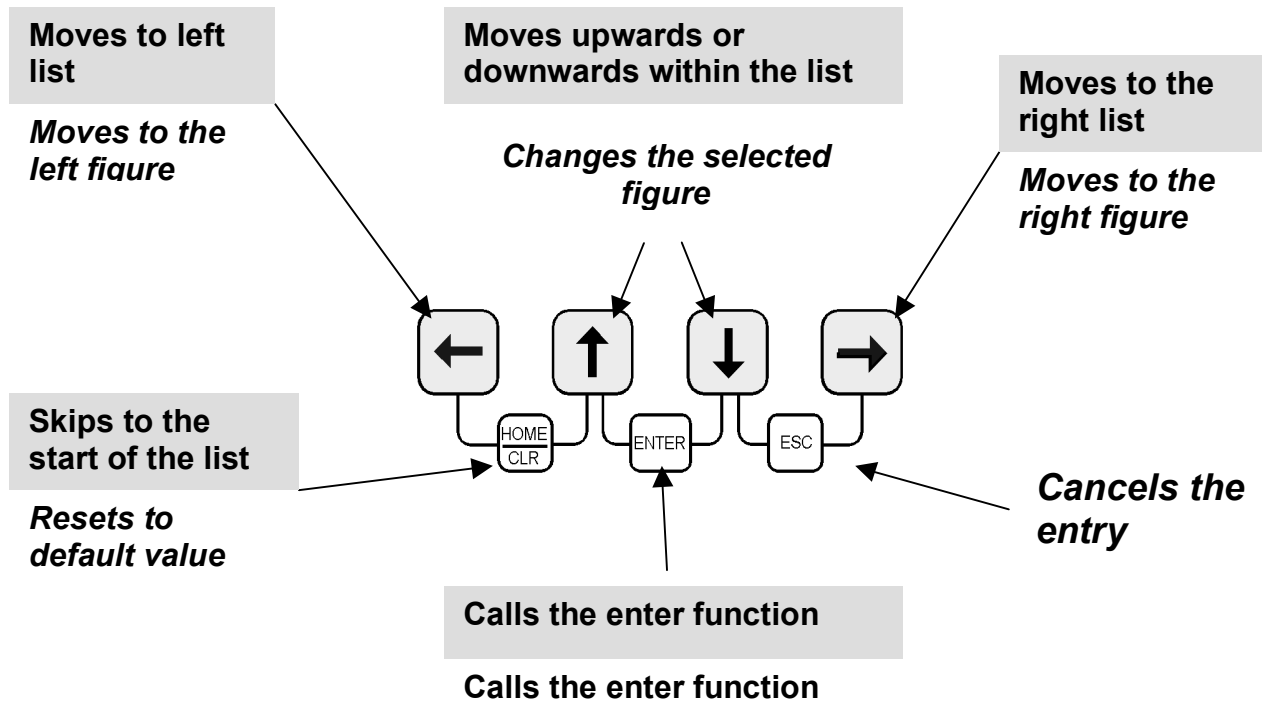

Note: The precise function of the keys during an entry is described in Chap. 2.5.2.

2.4 Formation of the list structure

The data display in the DL210 is structured in a tabular form. The individual columns in the table each contain associated values.

2.4.1 Summary charts, List Structure (1)

Input I1 is counter input		
↔ I1 to "User"	V1 Main counter I1	
	V1.A Adjustable counter I1	
	Q1 Flow rate I1	
	L.MI1 Limit for monitoring I1	
	Md.I1 Mode for I1	
	MdMI1 Mode for monitoring I1	
	SC.I1 Source for monitoring I1	
	CP.I1 cp value for I1	
	SNM Serial no. of Meter 1	
	DS.Ca DS-100 number for V1	
	DS.Cb DS-100 number for V1.P	
	CuNo Customer number I1	
	MP.I1 Measurement period I1	
	MP.Re Remain'g time in meas. period I1	
	Δ V1MP Incr. meas. period counter I1	
	Δ V1ML Last meas. period value I1	
	max V1MP Max. meas. per. counter Ex current month *	U1
	max V1ML Max. meas. per. counter Ex last month *	U1
	DB.I1 Day boundary for I1	
	Δ V1.Dy Current day counter I1	
	Δ V1D.L Last day value I1	
	max V1.Dy Max. day counter I1 current month *	U2
	max V1D.L Max. day counter I1 last month*	U2
	ArMo1 Month archive I1	U3
	ArDy1 Day value archive I1	U4
	ArMP1 Meas. period archive I1	U4
	FrMP1 Meas. period archive I1 frozen	

Input I1 is signalling input	
St.I1	Status of signal input I1
Md.I1	Mode for Input 1
MdMI1	Mode for monitoring I1
SC.I1	Source for monitoring I1
L.MI1	Limit for monitoring I1
Sp.I1	Status pointer

Remarks:

- For meaning of abbreviated designations: see Chapter 3 and Appendix C:
- Submenus are located under "U1" – "U9" (see Chapter: 2.4.5)
- * for flow recording and high flow display

2.4.2 Summary charts, List Structure (2)

Input I1 is encoder input			Input I2 is signalling input		
<i>or</i>	Vo	Original counter reading (encoder)	↔	St.I2	Status of signal input I2
	V1	Main counter I1		MdMI2	Mode for monitoring I2
	V1.A	Adjustable counter I1		SC.I2	Source for monitoring I2
	Q1	Flow rate I1		L.MI2	Limit for monitoring I2
	L.MI1	Limit for monitoring I1		SZ.I2	Status pointer
	Md.I1	Mode for I1			
	MdMI1	Mode for monitoring I1			
	SC.I1	Source for monitoring I1			
	CP.I1	cp value for I1			
	SNM	Serial no. of meter on Input 1			
	M.Dat	Meterdata I1		U9	
	DS.Ca	DS-100 number for V1			
	DS.Cb	DS-100 number for V1.P			
	CuNo	Customer number I1			
	MP.I1	Measurement period I1			
	MP.Re	Remain'g time in meas. period I1			
	Δ V1MP	Incr. meas. period counter I1			
	Δ V1ML	Last meas. period value I1			
	max V1MP	Max. meas. per. counter Ex current month *		U1	
	max V1ML	Max. meas. per. counter Ex last month *		U1	
	DB.I1	Day boundary for I1			
	Δ V1.Dy	Current day counter I1			
	Δ V1D.L	Last day value I1			
max V1.Dy	Max. day counter I1 current month *	U2			
max V1D.L	Max. day counter I1 last month*	U2			
ArMo1	Month archive I1	U3			
ArDy1	Day value archive I1	U4			
ArMP1	Meas. period archive I1	U4			
FrMP1	Meas. period archive I1 frozen				

Remarks:

- For meaning of abbreviated designations: see Chapter 3 and Appendix C:
- Submenus are located under "U1" – "U9" (see Chapter: 2.4.5)
- * for flow recording and high flow display

2.4.3 Summary charts, List Structure (3)

Status			System				
⇔	SReg	Total status register	U5	⇔	Time	Time and with "→" to date	⇔
to	Stat	Total momentary status	U6		MdTim	Summer / winter time on/off	to
"I2"	Clr	Clear total status register			MCyc	Measurement cycle	« Service »
	Logb.	Log book	U7		Disp	Permanent display on/off	
	AudTr	List of modifications	U8		Aut.V	Time to automatic display changeover	
	PLogb	PTB logbook	U8		SNo	Serial number DL210	
	ClrPL	Clear PTB logbook			Vers	Software version	
					Chk	Checksum software	

Service			
⇔	Bat.R	Residual service life of battery	⇔
to	Bat.C	Battery capacity	to
"System"	VBatM	Modem battery voltage	"Interface"
	St.SL	Status of supplier's lock	
	Cod.S	Supplier's combination	
	St.CL	Status of customer's lock	
	Cod.C	Customer's combination	
	St.PL	Status calibration lock	
	AdjTm	Correction factor, clock	
	Save	Backup of all data	
	Clr.A	Clear archives	
	Clr.V	Clear counters (incl. archives and readout notes)	
	Clr.X	Execute restart	
	Addr	User-specific display	
	diverse	Value of the user-specific display	
	Display test (all segments flash)		

Remarks:

- For meaning of abbreviated designations: see Chapter 3 and Appendix C:
- Submenus are located under "U1" – "U9" (see Chapter: 2.4.5)
-)
- * for flow recording and high flow display

2.4.4 Summary charts, List Structure (4)

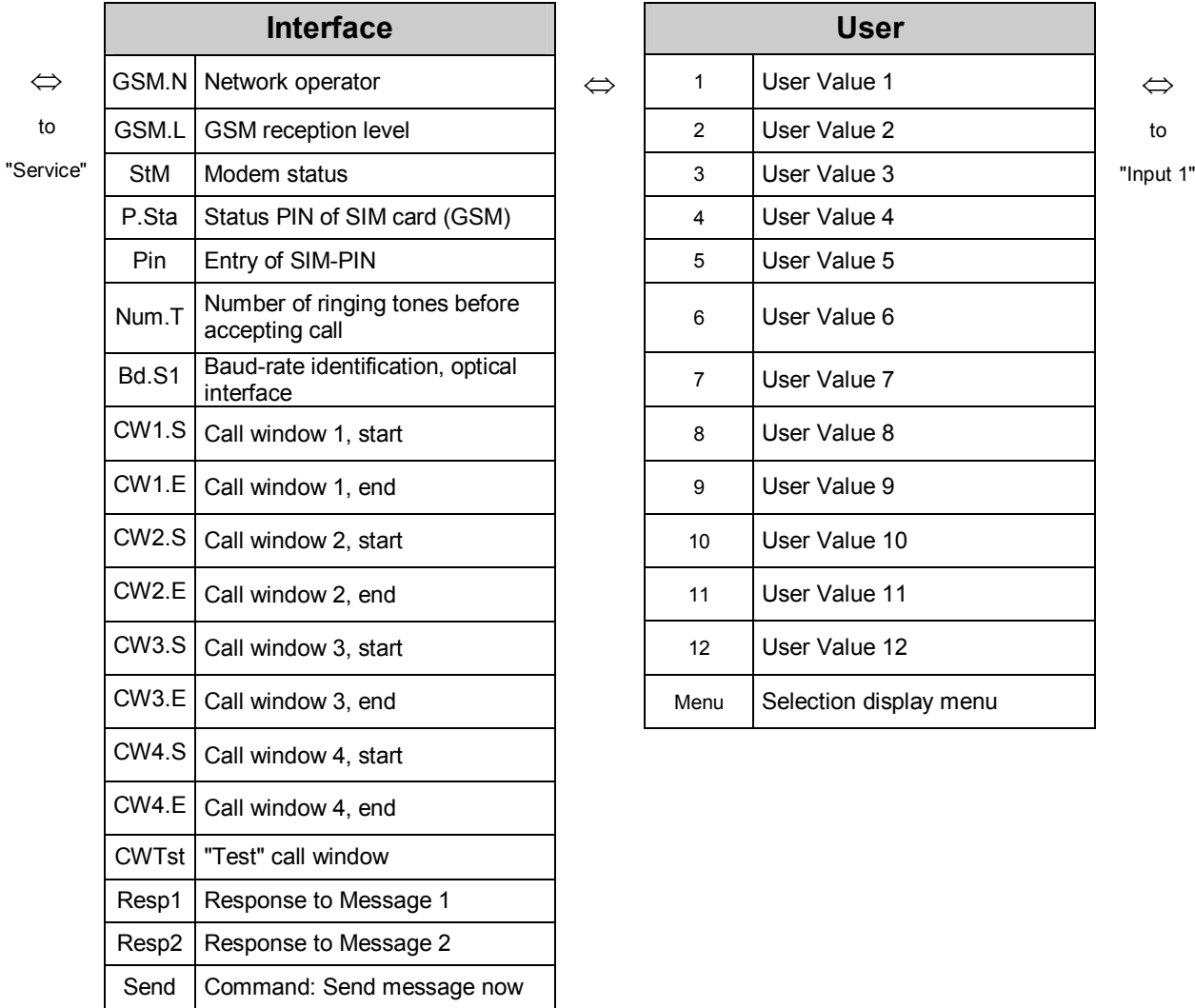

2.4.5 Summary charts, Submenus "U1" to "U9"

Note: Meaning of the abbreviated designations: See Chapter 3 and Appendix C:

U1 Submenu: "Max. measurement period counter I1"

to Date

⇐	TIME	⇐	(Date)	⇐
---	------	---	--------	---

 to TIME

U2 Submenu: "Max. day counter I1"

to Date

⇐	TIME	⇐	(Date)	⇐
---	------	---	--------	---

 to TIME

U3 Archive: "Month archive I1"

to Check

⇐	ABNo	⇐	TIME	⇐	(Date)	⇐	V1	⇐	V1.A	⇐
⇐	ABNo	⇐	TIME	⇐	(Date)	⇐	V1	⇐	V1.A	⇐

 to VxML

to Z "b"

⇐	V1ML	⇐	TIME	⇐	(Date)	⇐	Stat	⇐
⇐	V1ML	⇐	TIME	⇐	(Date)	⇐	Stat	⇐

 to VxD.L

to STAT

⇐	V1TL	⇐	TIME	⇐	(Date)	⇐	Stat	⇐	ST.x	⇐	St.Sy	⇐	Check	⇐
⇐	V1TL	⇐	TIME	⇐	(Date)	⇐	Stat	⇐	ST.x	⇐	St.Sy	⇐	Check	⇐

 to ABNo

U4 Archives: "Meas. period archive I1" and "Day value archive I1"

to Check

⇐	ABNo	⇐	TIME	⇐	(Date)	⇐	V1	⇐	Δ V1	⇐
⇐	ABNo	⇐	TIME	⇐	(Date)	⇐	V1	⇐	Δ V1	⇐
⇐	ABNo	⇐	TIME	⇐	(Date)	⇐	V1	⇐	Δ V1	⇐

 to Z "b"

to Δ "a"

⇐	V1.A	⇐	Δ V1.A	⇐	St.x	⇐	St.Sy	⇐	Ev	⇐	Check	⇐
⇐	V1.A	⇐	Δ V1.A	⇐	St.x	⇐	St.Sy	⇐	Ev	⇐	Check	⇐
⇐	V1.A	⇐	Δ V1.A	⇐	St.x	⇐	St.Sy	⇐	Ev	⇐	Check	⇐

 to ABNo

U5, U6 Status archives, explanation: see Chapter 0

U7 Archive: "Logbook"

to Check

⇐	ABNo	⇐	TIME	⇐	(Date)	⇐	Ev	⇐	Check	⇐
⇐	ABNo	⇐	TIME	⇐	(Date)	⇐	Ev	⇐	Check	⇐
⇐	ABNo	⇐	TIME	⇐	(Date)	⇐	Ev	⇐	Check	⇐

 to ABNo

U8 Archives: "Audit trail" and "PTB logbook"

to Check

⇐	ABNo	⇐	TIME	⇐	(Date)	⇐	Addr	⇐	"old"	⇐	"new"	⇐
⇐	ABNo	⇐	TIME	⇐	(Date)	⇐	Addr	⇐	"old"	⇐	"new"	⇐
⇐	ABNo	⇐	TIME	⇐	(Date)	⇐	Addr	⇐	"old"	⇐	"new"	⇐

 to St.PL

to "new"

⇐	St.PL	⇐	St.ML	⇐	St.SL	⇐	St.CL	⇐	Check	⇐
⇐	St.PL	⇐	St.ML	⇐	St.SL	⇐	St.CL	⇐	Check	⇐
⇐	St.PL	⇐	St.ML	⇐	St.SL	⇐	St.CL	⇐	Check	⇐

 to ABNo

U9 Encoder data, explanation: see Chapter 0

2.5 Changing values

2.5.1 Differentiating between values (data classes)





The methods of changing values differ depending on the value. These are therefore subdivided into so-called "data classes". Each value in a data class is treated identically on entry. The following data classes are present in the DL210:

Type	DC ¹	Description	Change via "ENTER"
Constant	1	Value is permanently specified	No change possible.
Measurements	2	Value determined by measurement (e.g. flow rate)	Displayed value is updated.
Steady values	3	Parameters (e.g. serial number, c _P value)	Change possible depending on state of lock; values can be changed in permissible range.
Discrete values	4	Parameters which can only assume a few permanently defined values (e.g.: Mode, input)	Change possible depending on state of lock; values can be changed in predefined range.
Initial. values	5	Values which can only be set to their initial value (e.g.: status register).	Change possible depending on state of lock; values can be changed to initial values.
Trigger function	6	Functions which can be triggered via keypad (e.g. Clear counter).	Change possible depending on state of lock; trigger by changeover to "1" and terminating with "ENTER".
Combination	7	Opening / closing the supplier's lock.	Similar to "Permanent values", but with masked entry.
Archive values	8	Display of the archived values possible in Data Classes 1-3.	No change possible.
-	9	Not used in the DL210.	
Headings	10 / 11	Heading for archives (10) or submenus (11).	Branching to the appropriate menu (submenu)

























































¹ DC: Data Class; one of the 11 data classes is assigned to each value.

2.5.2 Entry function

Depending on the data class slight differences exist for the entry of values. The following points are the same for all data classes:

- **ENTER**  +  activates the entry mode (appropriate numbers flash) and terminates the entry of a value with acceptance of the valid value.
- **ESC**  +  cancels an entry; the previous value is retained.
- After termination of the entry the display mode is again active.

In the various data classes the following actions in the entry mode lead to different functions:

DC	Action	Function
1	 +  ENTER	Entry not possible (constant)
2	 +  ENTER	Entry not possible; only refreshing of measurement
3	 +  ENTER	Entry mode becomes activated, the most significant figure flashes.
	 ,  ,  , 	The value of the flashing figure can be changed from 0 to 9 via the keys  ,  . Further figures to be changed are selected with the keys  ,  . Acceptance of the changed numerical value occurs with ENTER.
	 +  HOME/CLR	The value is described with its default setting, refer to field "Default" in Appendix C: .
4	 +  ENTER	Entry mode becomes activated, the complete number flashes.
	 ,  ,  , 	The next higher, respectively lower, valid value is superimposed with  ,  . Acceptance of the changed numerical value occurs with ENTER. No reaction to:  , 
	 +  HOME/CLR	The value is described with its default setting, see the field "Default" in the description of the individual lists.
5	 +  ENTER	Entry mode becomes activated, the complete number flashes.
	 ,  ,  , 	The display can be set to its initial value with  and  . Value acceptance is made with ENTER. No reaction to:  , 
	 +  HOME/CLR	The value is described with its default setting, see the field "Default" in the description of the individual lists.
6	 +  ENTER	Entry mode becomes activated, "0" or "1" flashes.
	 ,  ,  , 	Toggling between "0" and "1" can be carried out with  or  . With "1" the function is executed when ENTER is pressed. The successful execution of the function is indicated with "OK", and an error with "Error".
	 +  HOME/CLR	No function.
7	 +  ENTER	After ENTER the masked entry mode is activated.
	 ,  ,  , 	Entry similar as with Data Class 3, but masked. An accurate description is given under the list "System".

DC	Action	Function
	← + ↑ HOME/CLR	No function.
8	↓ + ↑ ENTER	Entry not possible (e.g. archive values) in archive: initiation of the skip function (see Chap. 3.2.5.2).
9	↓ + ↑ ENTER	Data class not present.
10	↓ + ↑ ENTER	Branching occurs to the appropriate submenu after ENTER.
/	↓ + → ESC	Return from the submenu into the main menu.
11	↓, ↑, ←, →	No function.
	← + ↑ HOME/CLR	No function.

2.5.3 Entry errors

Entry errors are output to the display if incorrect entries are made via the keypad by the operator.

The display is structured as follows:

----x--- x = Error code according to the following table:

Error code	Description
1	The archive is empty. (No entries present in the selected archive.)
2	The archive value is erroneous.
4	The parameter is write-protected.
5	The required lock is closed. An attempt has been made to change a value protected by a lock (e.g. calibration or supplier's lock), although it is closed.
6	The entered value is outside of the permissible value range.
7	The entered supplier's combination is not correct.
8	No Find function (e.g.: in the archive) is possible.
11	This message can have two causes: The queue of the messages to be sent is full. Up to ten messages can be temporarily saved. The definitions needed for sending the message (Short Message "SM") are not complete or are incorrect. E.g. the "SMS mode" must be "1" or "2", a correct telephone number must be entered for the receiver and provider, etc., (refer to Chapter 3.6.4 from page 88).
12	The value with the entered address cannot be used here.
13	To be able to execute the function "CLR.X", the clock must be reset to the start date (default date). (see Chap. 3.5.1)

2.5.4 Example of changing values

"Adjustable counter" on **Input 1** is to be changed (short designation: **V1.A**):

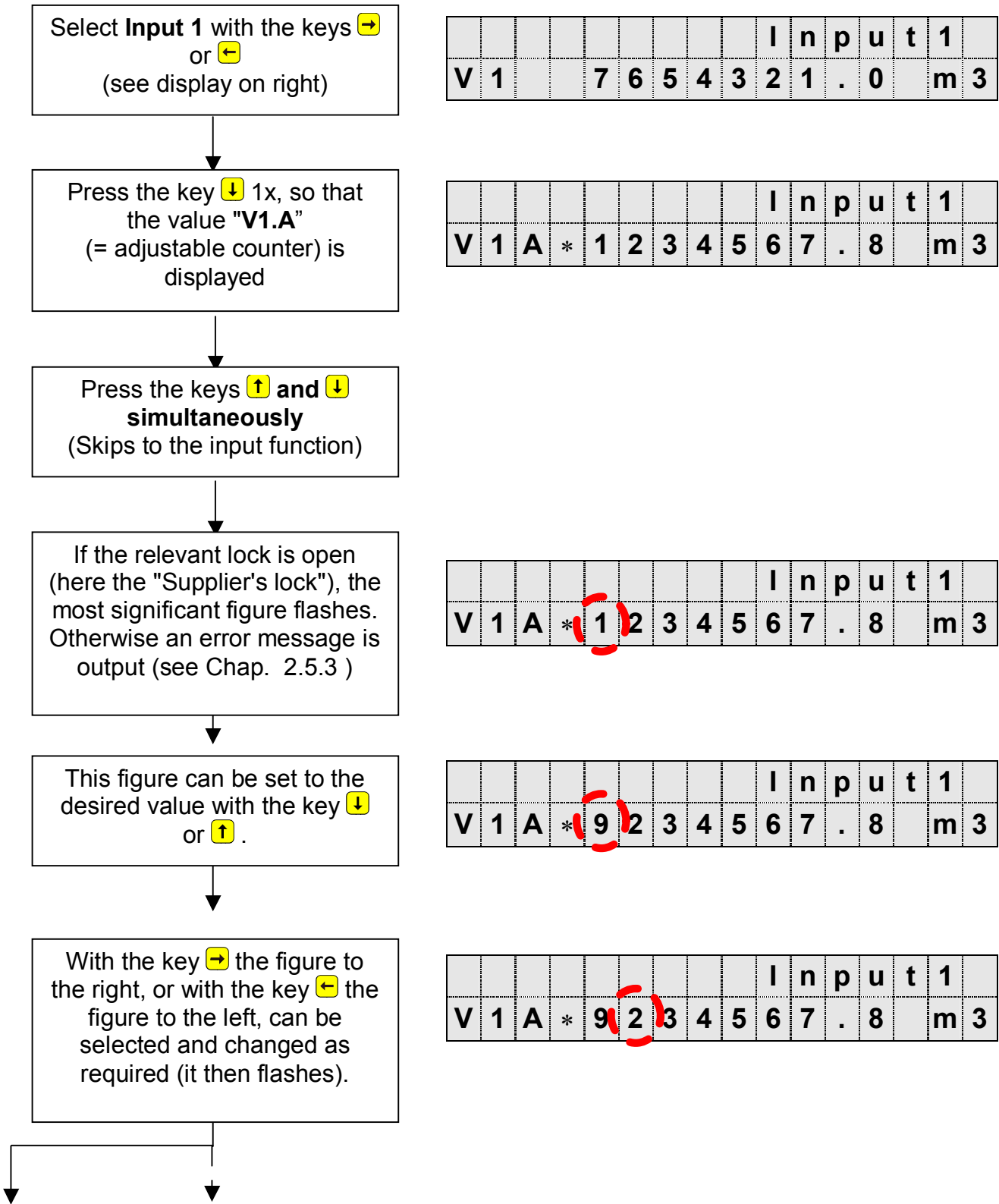

Through simultaneous pressing of the key **↑** and **←** (function "HOME/CLR") the value (e.g. a counter reading) can be reset directly to its default value ("0").

Input 1												
V	1	A	*	0	0	0	0	0	0	.	0	m 3

Cancellation of the input occurs by simultaneously pressing **↓** and **→** (function "ESC" = Cancel).

Input 1													
V	1	A	*	1	2	3	4	5	6	7	.	8	m 3

To terminate the entry press the keys **↑** and **↓** **simultaneously**. The function "ENTER" is then closed.

Input 1													
V	1	A	*	9	8	7	6	5	4	3	.	0	m 3

The changed value is saved in the EEPROM and becomes immediately valid.

2.6 Securing the values (access rights)

Within the DL210 a setting can be made for each existing value of whether it can be read and/or written by the appropriate access parties. This enables the DL210 to be used in a very flexible manner. In the field subject to calibration regulations, the rights are appropriately preset.

The following "access parties" are defined in the DL210:

- **Calibration official** **"P"** Access via calibration button located in the DL210.
- **PTB logbook:** **"PL"** Access via supplier's combination when the PTB logbook is not full.
- **Supplier** **"S"** Access via supplier's combination
- **Customer** **"C"** Access via customer's combination

For each value it can be defined whether the above-mentioned access party may read the value or write to it. Under which lock the desired value (for the factory setting) is located is described in the following chapters (refer to Chap. 3 and following pages).

These are to be followed, because WinPADS can be installed as a testing station, supplier's or customer's version and access to the device occurs accordingly.

☞ **If, for example, the supplier's lock is open (factory setting), the customer can also change the supplier's values!**

Depending on the application, an input which is not to be used as an input subject to calibration regulations can also be placed under the supplier or customer lock to be able to use it, for example, as a signalling input. A change is however only possible with the calibration lock open.

2.6.1 Calibration lock and calibration switch

The highest ranking lock for securing the calibration parameters is the calibration lock. All values, for example which are used for the processing and storage of volume counters, are subject to this lock. The calibration lock applies both to entries via the keypad as well as for access via the optical or internal modem interface. If the lock is locked, all attempts to set values are acknowledged with an appropriate error message (see Chap. 2.5.3).

The calibration switch is realised as a pushbutton and is located inside the DL210 next to the battery and is sealed with a sealing label.

The calibration lock is opened by actuating the button once (a flashing "P" appears in the display under the membrane label "Status") and also closed again (flashing "P" goes out).

The parameters protected under calibration regulations are each identified with "C" in the lists in the functional description.

2.6.2 Access lock "PTB logbook"

The DL210 has a calibration logbook in which changes of parameters subject to the calibration lock are saved. Parameters which are written into the logbook during a change are identified in the menu list of the function description (Chapter 3) with the access right "PL". When the PTB logbook is not full, these parameters can only be changed with the

supplier's lock open. If the PTB logbook is full, these parameters can only be changed with the calibration lock open.

☞ **With a full PTB logbook an open calibration lock cannot be closed. In this case the PTB logbook must first be deleted (see Chap.: 3.3.1)!**

2.6.3 Supplier and customer locks

The supplier and customer locks are used to protect all data which are not relevant to calibration and which, where applicable, need to be changed by the supplier and/or customer.

The lock function applies both to entries via the keypad as well as for access via the interfaces. If the respective lock is locked, all attempts to set or read values are acknowledged with an appropriate error message (see Chap.: 2.5.3).

The parameters protected under the supplier's lock are each identified with "S" in the lists in the functional description.

All values which are not labelled, (shown with "-") cannot be changed, because they represent, for example, measurements or constants.



The supplier and customer locks consist of an 8-figure code number.

The locks can only be changed when they themselves are open or a higher ranking lock is open. The calibration lock has the highest priority. So with the calibration lock open, parameters can also be changed which are subject to the supplier's lock.

2.6.4 Opening, changing and closing the supplier's lock

Displaying the current status of the supplier's lock

The supplier's lock is located in the Service list.

To display the current status select the Service list (top right of display: "Serv.") with the keys  or .

Then press the key  three times so that the following display appears:



					o	k	.		S	e	r	v	.				
S	t	.	S	L													0

The display of "0" indicates a closed supplier's lock.

Opening the supplier's lock

To open the lock the key  must be pressed once more so that the following display appears:



					o	k	.		S	e	r	v	.		
C	o	d	.	S				-	-	-	-	-	-	-	-

Press the keys  and  **simultaneously** (skip to entry function). Now the first figure flashes and all others are not displayed.

C	o	d	.	S											
									-	-	-	-	-	-	-

This figure can be set to the desired value with the key  or .

The next figure is selected (it then flashes) with the key  and can be entered according to the specified lock. The same procedure is used with all figures until the correct code has been entered. Here, it need not be entered right-justified, i.e. the code "1234" can be entered directly in the first four left segments; it is then automatically moved to the right.

Once the entry of the code is concluded, the keys  and  must be pressed **simultaneously** again. The entry is then concluded.

If the code is correct, the display "Cod.S" (see above) is again shown and by pressing the key  once, the status of the supplier's lock is displayed again:

					o	k	.		S	e	r	v	.		
S	t	.	S	L											1





The display of "1" now indicates an open supplier's lock.

If the code is not correct, the message "----7--" appears briefly and the entry must be repeated.



Changing the supplier's lock

If the supplier's lock is open, a new supplier's combination is entered under the display:



					o	k	.		S	e	r	v	.		
C	o	d	.	S				-	-	-	-	-	-	-	-

in the same manner. To do this, press the keys  and  **simultaneously** (skip to entry function). The first figure flashes. All other figures are now displayed. This figure can be set to the desired value with the key  or .

The next figure can be selected with the  and entered as described above.



Once the entry of the code is concluded, the keys  and  must be pressed **simultaneously** again. That then concludes the entry and the supplier's combination has been changed.

Closing the supplier's lock

To close the supplier's lock the status of the supplier's lock must again be recalled in the "Service" list (select the Service list with the keys  or  and press the key  three times), so that the following display appears:



					o	k	.		S	e	r	v	.		
S	t	.	S	L											1

The display of "1" indicates that the supplier's lock is still open.

Press the keys  and  **simultaneously** (skip to entry function). Now the right figure flashes:

S	t	.	S	L											1

Set this figure to the value "0" with the key  or .

Once the entry is concluded, press the keys  and  **simultaneously** again. The entry is then concluded and the supplier's lock is closed.

2.6.5 Opening, changing and closing the customer's lock

The customer's lock is located in the "Service" list. The procedure for opening, changing and closing corresponds to that of the supplier's lock. Here, the following displays are recalled:

Display of the status and closing of the customer's lock:

					o	k	.	S	e	r	v	.		
S	t	.	C	L										0

Opening the customer's lock and changing the combination:

					o	k	.	S	e	r	v	.		
C	o	d	.	C				-	-	-	-	-	-	-

3 Functional description

The data display is structured in tabular form (list structure) (see Chapter 2.4). The individual columns in the table each contain associated values. The following functional description is orientated to this list structure.

3.1 List structure for Input 1 and Input 2

3.1.1 Input 1 set as counting input

Name	Address	Designation / value	Cal.	Access	Default	DC
V1	1:200	Main counter input 1	Yes	PL	0	3
V1.A	1:203	Adjustable counter I1	No	S	0	3
Q1	1:210	Flow rate I1	-	-	-	2
L.MI1	12:150	Limit for monitoring I1	No	C	50000	Var.
Md.I1	1:207	Mode I1	Yes	PL	1	4
Md.MI1	12:157	Mode for monitoring I1	No	S	2	4
SC.I1	12:154	Source for monitoring I1	No	S	1:160	Var.
cp.I1	1:253	Cp value I1	Yes	PL	1	3
SNM	1:222	Serial number of meter on I1	No	S	2	3
DS.Ca	1:22E	DS-100 number for Counter V1	No	S	see Ser.No	3
DS.Cb	1:22F	DS-100 number for Counter V1.A	No	S	see Ser.No	3
CuNo	1:21A	Customer number I1	No	S	1	3
Mp.I1	5:150	Measurement period I1	Yes	PL	60	3
MP.Re	5:15A	Residual measurement period I1	-	-	-	2
Δ V1Mp	1:160	Counter read'g of curr. meas. period I1	Yes	-	-	2
Δ V1M.L	1:161	Counter reading of last meas. period I1	Yes	P	-	2
max V1Mp	3:160	Maximum of meas. period counter reading in current month I1*	Skip to submenu for display of date / time			11
max V1M.L	3:161	Max. meas. per. counter I1, last month*	Skip to submenu for display of date / time			11
DB.I1	5:141	Day boundary I1	Yes	P	06:00	3
Δ V1.Dy	2:160	Incr. day counter I1	Yes	-	-	2
Δ V1D.L	2:161	Last day counter I1	Yes	-	-	2
maxV1.Dy	4:160	Max. day counter I1 in curr. month*	Skip to submenu for display of date / time			11
maxV1D.L	4:161	Max. day counter I1, last month*	Skip to submenu for display of date / time			11
ArMo1	1:A30	Month archive I1	Skip to "Month archive I1"			10
ArDy1	13:A30	Day value archive I1	Skip to "Day value archive I1"			10
ArMP1	2:A30	Measurement period archive I1	Skip to "Measurement period archive I1"			10
FrMP1	2:A50	Freeze measurement period archive I1	No	S	-	6

DC = Data class (for description see Chap. 2.5.1, page 25.)

P/PL/S/C = The displayed value is subject to: "**P**": Calibration lock "**PL**": PTB logbook "**S**": Supplier's lock "**C**": Customer's lock "-": Value cannot be changed.

* = for flow recording and high flow display

3.1.2 Input 1 set as encoder input

Name	Address	Designation / value	Cal.	Access	Default	DC
Vo	1:240	Original counter, Input 1 (encoder counter)	Yes	-	0	3
V1	1:200	Main counter input 1	Yes	PL	0	3
V1.A	1:203	Adjustable counter, I1	No	S	0	3
Q1	1:210	Flow rate I1	-	-	-	2
L.MI1	12:150	Limit for monitoring I1	No	S	50000	Var.
Md.I1	1:207	Mode I1	Yes	PL	1	4
Md.MI1	12:157	Mode for monitoring I1	No	S	2	4
SC.I1	12:154	Source for monitoring I1	No	S	1:160	Var.
cp.I1	1:253	Cp value I1	Yes	PL	1	3
SNM	1:222	Serial number of the meter on I1	No	S	2	3
Z.Dat	2:01C1	Encoder data	Skip to submenu			11
DS.Ca	1:22E	DS-100 number for Counter V1	No	S	see Ser.No	3
DS.Cb	1:22F	DS-100 number for Counter V1.A	No	S	see Ser.No	3
CuNo	1:21A	Customer number for Input I1	No	S	1	3
MP.I1	5:150	Measuring period input I1	Yes	PL	60	3
MP.Re	5:15A	Residual measurement period I1	-	-	-	2
Δ V1MP	1:160	Consumption in the current meas. period I1	Yes	-	-	2
Δ V1ML	1:161	Consumption in the last meas. period I1	Yes	P	-	2
V1MP _{max}	3:160	Maximum of meas. period consumption in current month*	Skip to submenu			11
V1ML _{max}	3:161	Max. meas. period consumption in last month*	Skip to submenu for display of date / time			11
DB.I1	5:141	Day boundary I1	Yes	P	06:00	3
Δ V1.Dy	2:160	Current day counter I1	Yes	-	-	2
Δ V1D.L	2:161	Last day counter I1	Yes	-	-	2
V1DB _{max}	4:160	Max. day counter I1, current month*	Skip to submenu			11
V1D.L _{max}	4:161	Max. day counter I1, last month*	Skip to submenu			11
ArMo1	1:A30	Month archive I1	Skip to "Month archive I1"			10
ArDy1	13:A30	Day value archive I1	Skip to "Day value archive I1"			10
ArMP1	2:A30	Measurement period archive I1	Skip to "MP archive I1"			10
FrMP1	2:A50	Measurement period archive I1 frozen	No	S	-	6

DC = Data class (for description see Chap. 2.5.1, page 25.)

P/PL/S/C = The displayed value is subject to: "**P**": Calibration lock "**PL**": PTB logbook "**S**": Supplier's lock "**C**": Customer's lock "-": Value cannot be changed.

* = for flow recording and high flow display

3.1.3 Input 1 set as signal input

Name	Address	Designation / value	Cal.	Access	Default	DC
St.I1	1:228	Status I1	-	-	-	2
Md.I1	1:207	Mode I1	Yes	PL	2	4
Md.MI1	12:157	Mode for monitoring I1	No	S	2	4
SC.I1	12:154	Source for monitoring I1	No	S	1:0160	Var.
L.MI1	12:150	Limit for monitoring I1	No	S	50000	Var.
SpM1	12:153	Status pointer	No	S	12_01:1.1	4

DC = Data class (for description see Chap. 2.5.1, page 25.)

P/PL/S/C = The displayed value is subject to: "**P**": Calibration lock "**PL**": PTB logbook "**S**": Supplier's lock "**C**": Customer's lock "-": Value cannot be changed.

3.1.4 Input 2 is signalling input (unmodifiable)

Name	Address	Designation / value	Cal.	Access	Default	DC
St.I2	2:228	Status I2	-	-	-	2
Md.MI2	13:157	Mode for monitoring I2	No	S	2	4
SC.I2	13:154	Source for monitoring I2	No	S	2:0228	Var.
L.MI2	13:150	Limit for monitoring I2	No	C	1	Var.
SpM2	13:153	Status pointer I2	No	S	13_02:1.1	4

DC = Data class (for description see Chap. 2.5.1, page 25.)

P/PL/S/C = The displayed value is subject to: "**P**": Calibration lock "**PL**": PTB logbook "**S**": Supplier's lock "**C**": Customer's lock "-": Value cannot be changed.

3.1.5 Description of the values

The values are described for Input 1 as an example. The corresponding values in the list Input 2 (only signalling input) have the same function as with Input 1.

Vo Original counter Input 1

This counter is only provided in the encoder mode (Md.I1 = 5 or 7 or 8). It indicates the counter reading read from the encoder. This value is displayed with 9 predecimal places. Pressing the key "→" displays the 4 post-decimal places. The counter value cannot be changed.

V1 Main counter, Input 1

Pulse mode (Md.I1=1): The counter counts the incoming pulses and converts them into a volume using the set cp value.

Encoder mode (Md.I1=5 or 7 or 8): The counter is brought to its current counter reading when the encoder is read out for the first time. With each further read-out it is updated by the *increment* of the encoder counting mechanism.

With an open calibration or supplier's lock (with entry in the PTB logbook) the value can be changed based on the description in Chapter 2.5.2. The display occurs during entry in the full format of nine predecimal and four post-decimal

places. Otherwise this value is displayed with 9 places before the decimal point. Pressing the key "→" displays the 4 post-decimal places.

V1.A Adjustable counter Input 1

With the supplier's lock open the adjustable counter can be set via the keypad or interface to any value. The incremental progress and display correspond to the main counter V1.

Q1 Flow Input 1

Momentary flow rate at the input converted to m³/h (uncalibrated). The display is given in full cubic metres (without post-decimal places).

St.I1 Status input 1

St.I2 Status Input 2

Momentary status of the input if it is programmed as a signalling input ("0" = open; "1" = closed).

L.MI1 Limit for the monitoring function

L.MI2 Limit for monitoring function

Limit for the value on the present input defined by MdMI1 or MdMI2 (see below). The representation of the limit occurs according to the set mode **MdMI1**.

SpMI1 Status pointer for monitoring

SpMI2 Status pointer for monitoring

Here is defined which message in the status register of the input appears when the set limit is infringed. **Md.I1 Mode, signal input I1**. The signal input 1 of the DL210 can be assigned with various input modes. The following modes are realised:

"0" = Input switched off

The input has no function.

"1" = Counting input

Pulses on Input 1 are counted as volume pulses.

"2" = Status input

Here the input is used as the status input. The type of status signal (e.g. "N/C", "N/O" or time-synchronised signal) is defined with the mode for monitoring **MdMI1** (see below).

"5" = Encoder input "Namur"

A Namur encoder is connected to Input 1.

"7" = Encoder input "SCR EDIS 95"

An SCR encoder with EDIS 95 protocol is connected to Input 1.

"8" = Encoder input "SCR OBIS 05"

An SCR encoder with OBIS 05 protocol is connected to Input 1.

"99" = Automatic detection If the detection was successful, the input mode is set automatically to the corresponding encoder type and the counter Vo displayed. If no encoder could be detected, the input is set to pulse mode and the counter V1 displayed.

MdMI1 Mode for monitoring Input 1**MdMI2 Mode for monitoring Input 2**

Various modes for monitoring can be programmed. The following modes are possible:

Mode for monitoring		Explanation ¹
0	Switched off	No monitoring
1	> L.MI1	Limit exceeded (value > L.MI1)
2	≥ L.MI1	Limit exceeded (value ≥ L.MI1)
3	< L.MI1	Limit undercut (value < L.MI1)
4	≤ L.MI1	Limit undercut (value ≤ L.MI1)
5	Time-synchronous input	Time-synchronous input, rising edge

Depending on the system other values can be set (6, 9, 10, 12, 13, 17, 21, 23 and 33). However, here they cannot be used practicably and should therefore not be set.

SC.I1 Source for monitoring Input 1**SC.I2 Source for monitoring Input 2**

With activated monitoring and in dependence of the programmed mode (MdMI1 or MdMI2), a source must also be defined, with the contents of which the limit is compared (i.e. the value that is to be monitored).

The address of the value to be monitored must be set as a source. The following sources are practicable in dependence of the set mode (extract only):

Mode for monitoring		Source for monitoring
0	Switched off	No monitoring.
1	> L.MI1	1:160 (V1MP, measuring period counter)
2	≥ L.MI1	2:160 (V1Dy, day counter)
3	< L.MI1	1:210 (Q1, flow)
4	≤ L.MI1	1:228 (St.I1, input status, Input 1)
5	Time-synchronised input	1:228 (St.I1, input status, Input 1)

CP.I1 cp value signal input I1

The cp value states the pulse weighting as pulses per unit, pulses/m³. The value is displayed with eight places without leading zeroes in which 5 predecimal and 3 post-decimal places are used.

The cp value of the input does not influence the format of the counter readings. They are always displayed with nine predecimal and four post-decimal places.

SNM Serial number of the meter (4 + 8 places)

Here the 12-figure serial number of the meter connected to this signal input is displayed. Ex-works 000000000002 is the default.

¹ The "value" quoted here can be freely set with "SC.I1" or "SC.I2".

Z.Dat Encoder data

Entry option into the submenu for displaying the encoder-specific data (refer to Chap. 3.1.6) when an encoder operating mode is set.

DS.Ca DS-100 number, Counter V1

To differentiate between the two counters V1 and V1.A in the archives for the Elster-Instromet Evaluation Software WinVIEW, a so-called "DS-100 number" is needed for each counter. This number is pre-assigned at the factory based on the fabrication number of the DL210 and does not need to be changed.

DS.Cb DS-100 number, Counter V1.A

See "DS.Ca"

CuNo Customer number (4 + 8 places)

Here the 12-figure customer number of the connected meter is displayed. Ex-works "000000000001" is the default.

Mp.I1 Measurement period, Input I1

Setting of the measurement period for saving the data records (counter readings) in the archive of Input 1. The output is given right-justified in minutes.

MP.Re Remaining time measurement period

Display of remaining time for the current measurement period for the user's information. The output is given right-justified in minutes.

Δ V1MP Measurement period counter I1

Display of the counter input volume measured during the current measurement period (momentary reading for measurement period consumption). The display occurs as described under "Main counter".

Δ V1ML Last measurement period counter I1

Displays the last measurement period consumption

max V1Mp Max. measurement period counter in current month I1 for flow recording and maximum flow display

The maximum of the measurement period found on the counter input till now in the current month. The display is described under "Main counter".

This display item is also the entry in the *submenu* in which the corresponding date and time can be called.

max V1M.LMax. measurement period counter in the last month I1 for flow recording and maximum flow display

The maximum of the measurement period found on the counter input in the last month. The display is described under "Main counter".

This display item is also the entry in the *submenu* in which the corresponding date and time can be called.

DB.I1 Day boundary I1 It is entered right justified in the form hh:mm. It affects the change of day and, where applicable, archiving in the monthly archive.

Δ V1.Dy Day counter I1

The volume of the counting input (current level of day's consumption) found during the current day depending on the day boundary DB.I1. The display occurs as described under "Main counter".

Δ V1D.L Last day counter I1

Displays the consumption of the last day.

max V1.Dy Maximum day counter I1 in current month for flow recording and maximum flow display

Day maximum found till now on counter input in the current month depending on the day boundary. The display is described under "Main counter".

This display item is also the entry in the *submenu* in which the corresponding date and time can be called.

max V1D.L Maximum day counter I1 in last month for flow recording and maximum flow display

Day maximum found on the counter input in the last month depending on the day boundary. The display is described under "Main counter".

This display item is also the entry in the *submenu* in which the corresponding date and time can be called.

ArMo1 Month archive I1

Entry possibility into the month archive of Input 1, if this is programmed as counter input or encoding input (for structure see Chapter 3.2.2).

ArDy1 Day value archive I1

Entry possibility into the day value archive of Input 1, if it is programmed as a counter or encoding input (for structure see Chapter 3.2.3).

ArMP1 Measurement period archive I1

Entry possibility into the archive of measurement period values (meter reading response, or load profile) of Input 1, if this is programmed as counter or encoder input (for structure see Chapter 3.2.3).

FrMP1 Freeze measurement period archive I1

Manual method of saving a data record of the measurement period archive (independent of the measurement period). It is used for saving a momentary value; no new measurement period is started. In the archive this type of data record can be recognised based on the triggering event; (label: FrMP1↑ = Freeze command).

The following other values are also available for Input 1:

Measuring point designation to AA

Address: **1:221**

A 33-place designation of the measuring point can be saved in the DL210. As a result, the requirements of the Association Agreement (AA) can be optimally considered.

Unit

Address: **1:208**

Each input can be assigned a unit (default: "m3") which is composed of five characters and can only be displayed. Any text string can be entered here, which though has no effect on the counter readings, etc.







SW debounce

Address of period: **1:232**

Address for pulse duration: **1:233**

When the connected meter outputs fluctuating pulses, a software debounce can be activated under the above addresses with the calibration lock open. It is adjustable with a pitch of 63 ms. Further information can be obtained from Elster-Instromet GmbH.

3.1.6 Submenu encoder data

Under "Z.Dat" skipping into the submenu: "Encoder data" can be made with "ENTER" (press arrow keys  and  simultaneously). The data provided by the encoder can be seen in this submenu. The single entries can be called with the keys  and . Values present in the menu but not provided by the connected encoder can be entered manually as required. The submenu can be quit with "ESC" (press arrow keys  and  simultaneously).

3.1.6.1 Encoder data Namur

AD	Designation / value	Unit	Access	Address	DC
Type	Meter or sensor type	-	S	1:223	8
Manuf	Manufacturer	-	S	1:241_1	8
SW.Z	version	-	S	1:241_3	8
Dat.Z	Date of manufacture	-	S	1:241_4	8
q.max	Maximum encoder flow	m3/h	S	1:23C	8
BdEnc	Encoder baud rate	Bd	S	1:244	7

DC = Data class (for description see Chap. 2.5.1, page 25.)

P/PL/S/C = The displayed value is subject to: "**P**": Calibration lock "**PL**": PTB logbook "**S**": Supplier's lock "**C**": Customer's lock "-": Value cannot be changed.

3.1.6.2 Encoder data SCR EDIS 95

AD	Designation / value	Unit	Access	Address	DC
Type	Meter or sensor type	-	S	1:223	8
SN.E	Encoder serial number	-	S	1:242	8
Manuf	Manufacturer	-	S	1:241_1	8
Med.	Medium	-	S	1:241_2	8
SW.Z	version	-	S	1:241_3	8
Dat.Z	Date of manufacture	-	S	1:241_4	8
q.max	Maximum encoder flow	m3/h	S	1:23C	8
BdEnc	Encoder baud rate	Bd	S	1:244	7

DC = Data class (for description see Chap. 2.5.1, page 25.)

P/PL/S/C = The displayed value is subject to: "**P**": Calibration lock "**PL**": PTB logbook "**S**": Supplier's lock "**C**": Customer's lock "-": Value cannot be changed.

3.1.6.3 Encoder data SCR OBIS 05

AD	Designation / value	Unit	Access	Address	DC
Type	Meter or sensor type	-	S	1:223	8
PrpNo	Property number	-	S	1:243	8
Manuf	Manufacturer	-	S	1:241_1	8
Med.	Medium	-	S	1:241_2	8
SW.Z	version	-	S	1:241_3	8
DateM	Date of manufacture	-	S	1:241_4	8
q.max	Maximum encoder flow	m3/h	S	1:23C	8
BdEnc	Encoder baud rate	Bd	S	1:244	7

DC = Data class (for description see Chap. 2.5.1, page 25.)

P/PL/S/C = The displayed value is subject to: "**P**": Calibration lock "**PL**": PTB logbook "**S**": Supplier's lock "**C**": Customer's lock "-": Value cannot be changed..

3.1.6.4 Description of the values

TYPE Meter or sensor type

Size or type of the meter, e.g. "G16T" or "G25".

Manuf Manufacturer

Display of the manufacturer's initials, e.g. "ELS" for Elster-Instromet.

SW.Z Version

Version display of the encoder firmware.

DateM Date of manufacture

Date of manufacture or date of the last calibration, e.g. "10.09.2005" or "Feb93" or "95WK34".

q.max Maximum encoder flow

Permissible flow maximum for plausibility check.

BdEnc Encoder baud rate

The baud rate for the transfer of data from the encoder to the DL210 can be set here, deviating from the standard, for special applications.

SN.E Encoder serial number

The encoder serial number (only for encoders with interface "SCR EDIS 95").

Med. Medium

Display of the measured medium in plain text, e.g. gas, water, etc. (not with encoders with interface "NAMUR").

PrpNo Property number

The encoder property number (only for encoders with interface "SCR OBIS 05").

3.2 Archives in the DL210

There are six different types of archive in the DL210:

- a) Measurement period archive
- b) Day value archive
- c) Month archive
- d) Logbook
- e) Changes archive
- f) PTB logbook

Apart from the PTB logbook all archives are structured as a ring buffer memory, so that the latest data is always available. The oldest data is overwritten by a new entry. For Input 1 there is a measurement period, day value and month archive. Along with the PTB logbook, the device provides a general logbook and a changes archive.

Description of the archives in detail:

About a) The measurement period archive contains the counter readings (meter reading response) which have been saved by the event "End of measurement period" or other events (counter reading change, time change, other signals). As standard the calibrated counter V1 and the adjustable counter V1.A are saved in the measurement period archive. In the encoder mode the encoder original counter V₀ can also be saved instead of V1.A.

About b) The day value archive contains the counter readings (meter reading response) from the above mentioned counters which have been saved by the event "End of day" or other events (counter reading change, time change, other signals).

About c) The month archive contains the month end readings of the above mentioned counters as well as the day and measurement period maxima formed. These are saved when the event "End of month" occurs.

About d) The logbook saves the last 250 non-periodic events (i.e. changes of status messages). The events relevant to calibration are also saved in the measurement period archives for the relevant inputs. For a description of the logbook: See Chapter: 0.

About e) The changes archive saves the last 200 parameter changes (before / after) which have been made via the keypad, opt. interface or modem communication. Description of the changes archive: See Chapter: 0.

About f) The PTB logbook saves the 50 changes of parameters relevant to calibration which may be changed with an appropriate entry into this logbook with the calibration lock closed and the supplier's lock open and without the presence of a calibration official. The parameter changes made (before / after) are saved via the keyboard, opt. interface or modem communication. The structure of this archive corresponds to the changes archive: See Chapter: 3.3.5.

3.2.1 Values common in all archives

Each archive data record consists of values which exist in all archives (e.g. time stamp, etc.) and values which label the relevant archive (e.g. which counter reading is saved). The values which exist in all archives and are displayed are described in the following. The structure of the individual archives and the values which label the relevant archive are explained in the next chapter.

ABNo Internal archive block number

This is a number from 1 to 65535 which is used as a label for **one** data record (corresponds to one row) in the archive. For the first time of saving the block number 1 is issued, then 2 etc. up to 65535. After an overflow counting starts from "0". The block numbers of all archives are set to 1 by the trigger function "Clear counter (incl. archive)".

Time Time / Date

The time and date at the time of saving a data record in the corresponding "Archive row".

St.Sy Momentary status

Saved momentary status when creating the data record.

Check Checksum evaluation

Here an evaluation of the checksum of the current data record for the "archive row" is displayed. The evaluation can have two possible results:

"CRC ok" = No errors in data record

"CRC Error" = Erroneous value in current data record.

If a data record contains errors, all values in the relevant row are displayed flashing in the display. They CANNOT be used for billing!

Checksum of a data record

In the DL210 a checksum is appended to each data record to ensure that the data is transferred correctly. Here, two errors are certain to be detected and one error can also be corrected (CRC-16 procedure). In the DL210 only a simple evaluation of the checksum is used without determining which value within the data record is erroneous. The checksum formed can be read out later by the evaluation systems.

3.2.2 Structure of the month archive Input 1

Under "ArMo1" a skip to the month archive for Input 1 can take place. In the month archive the month-end readings of the counters V1 and V1.A (see below) and the day and measurement period maxima found by the DL210 are retained (**high-flow display function**). They are saved for the last 15 months and can be used for billing purposes.

The month archive is only available for Input 1 in the pulse or encoder mode. **Instead of the counter "V1.A" the encoder original counter "Vo" can also be saved in the encoder mode.** Further information can be obtained from Elster-Instromet GmbH.

The following values are saved in this archive:

Data record no.	ABNo	Time (time of day)	Time (date)	Counter V1	Counter V1.A	V1M.L max	Time (time of day)	Time (date)
Explanation	(1)	(2)	(3)	(4)	(5)	(6)	(7)	(8)
1	1	06:00:00	01.02.04	11111111	00000123	00000123	12:00:00	15.01.04
2	2	06:00:00	01.03.04	22222222	00000456	00000234	07:00:00	12.02.04
3	3	06:00:00	01.04.04	33333333	00000789	00000345	18:00:00	25.03.04
...								

Data record no.	Stat	V1D.L max	Time (time of day)	Time (date)	Stat	St.1	St.Sy	Check
Explanation	(9)	(10)	(11)	(12)	(13)	(14)	(15)	(16)
1	x.y.z	00012345	06:00:00	23.01.99	x.y.z	x.y.z	x.y.z	OK
2	x.y.z	00023456	06:00:00	02.02.99	x.y.z	x.y.z	x.y.z	OK
3	x.y.z	00034567	06:00:00	25.03.99	x.y.z	x.y.z	x.y.z	OK
...								

Meaning of the displayed values:

ABNo	(1)	Internal archive block number
Time	(2)	Time of saving (at end of month)
Time	(3)	Date of saving (at end of month)
Counter V1	(4)	Calibrated counter V1 Counter reading of the counter at the time of saving.
Counter V1.A	(5)	Adjustable counter V1.A Counter reading of the counter at the time of saving.
V1M.L_{max}	(6)	Last measurement period maximum The measurement period maximum found at end of month.
Time	(7)	Time of the measurement period maximum The time of day determined when the measurement period maximum was saved.
Time	(8)	Date of the measurement period maximum The date determined at the time of saving the measurement period maximum.
Stat	(9)	Status at the measurement period maximum All signals on this input occurring during the measurement period maximum (for structure see Chapter 3.3.10).
V1D.L_{max}	(10)	Last day maximum The day maximum found at end of month.
Time	(11)	Time of the day maximum The time of day determined when the day maximum was saved.
Time	(12)	Date of the day maximum The date determined at the time of saving the day maximum.
Stat	(13)	Status at the day maximum lx All signals on this input occurring during the day of the day maximum (for structure see Chapter 3.3.10).
ST.1	(14)	Status register of the input I1 at time of saving (for structure see Chapter 3.3.10).
St.Sy	(15)	Momentary status of the system (complete device) at time of saving (for structure see Chapter 3.3.10).
Check	(16)	Checksum evaluation Display of whether the data row is correct (CRC ok) or faulty (CRC Error).

3.2.3 Structure of meas. period and day value archives Input 1

Under "ArMP1" skipping into the measurement period archive and under "ArDy1" skipping into the day value archive can occur. Here the readings of the Counters V1 and V1.A are saved (= "taking meter readings") as standard. The consumption values ($\Delta V1$ or $\Delta V1.A$) are determined for the display in the DL210 or calculated by the evaluation software based on the differences in counter readings.

The measurement period and day value archive are only available for Input 1 in the pulse or encoder mode. **Instead of the counter "V1.A" the encoder original counter "Vo" can also be saved in the encoder mode.** Further information can be obtained from Elster-Instromet GmbH.

Archive structure:

Data record no.	ABNo	Time (time of day)	Time (date)	Counter V1	$\Delta V1$	Counter V1.A	$\Delta V1.P$	ST.1	St.Sy	Ev	Check
Explanation	(1)	(2)	(3)	(4)	(5)	(6)	(7)	(8)	(9)	(10)	(11)
1	11111	06:00:00	01.04.04	33333333	x	44444444	X	x.y.z	x.y.z	xx.yy:z	OK
2	11112	07:00:00	01.04.04	33333444	111	44444444	0	x.y.z	x.y.z	xx.yy:z	OK
3	11113	08:00:00	01.04.04	33333499	55	44444489	45	x.y.z	x.y.z	xx.yy:z	OK
4	11114	09:00:00	01.04.04	33333555	56	44444523	34	x.y.z	x.y.z	xx.yy:z	OK
...											

ABNo (1) Internal archive block number

Time (2) Time of day

Time (3) Date

Counter V1 (4) Calibrated counter V1
Counter reading at the time of saving.

$\Delta V1$ (5) Counter increment of calibrated counters V1 and V2
Difference value at conclusion of measurement period (e.g. consumption)

Counter V1.A(6) Adjustable counter V1.A
Counter reading at time of saving.

$\Delta V1.P$ (7) Counter increment of adjustable counter V1.A or V2.A
Difference value at termination of measurement period (e.g. consumption)

ST.1 (8) Status register Input 1 at time of saving (see Chapter 3.3.8)

St.Sy (9) Momentary system status Input 1 at time of saving (for structure see Chapter 3.3.8).

Ev (10) Triggering event
E.g. appearance of a warning (for structure see Chapter 3.3.13).

Check (11) Checksum evaluation
Display of whether the data row is correct (OK) or faulty (ERROR).

3.2.4 Measurement period and memory depth

The depth of the measurement period archive is strongly dependent on the measurement period used and the signals that occur in the meantime. The following table gives an idea of the memory depth.

☞ **When setting the measurement period it is essential to take into account the DL210 "measurement cycle". See "MCyc" in Chapter 3.4.1.**

For Input 1 the following memory depth occurs for 11500 archive rows (without additional messages which are held in the archive):

Memory depth	Measurement period MP.I1 in minutes						
	2	5	10	15	20	30	60
Days	15.9	39.9	79.8	119.7	159.7	239.5	479
Months	-	1.3	2.6	3.9	5.2	7.8	15.7

3.2.5 Application as flow recording device

With the function "Flow recording device" the counter readings relevant to billing are contained in the **measurement period archive** for Input 1.

The readings of the counters are saved on the cycle of the set measurement period or additionally for appropriate events (meter reading response).

The calibrated counters (V1 and V2) and the adjustable counters (V1.A and V2.A) are saved in the archive. Consequently, both counters are available for billing.

The values of the measurement period archive can only be cleared with the calibration lock open and can be used for billing purposes.

The following values are in the archive, calibrated or uncalibrated:

ABNo	Time	DAT	V1	Δ V1	V1.A	Δ V1.A	ST.1	St.Sy	Ev	Check
-	calib'd.	calib'd.	calib'd.	calib'd.	un-calib'd	un-calib'd	un-calib'd	un-calib'd	un-calib'd	-

The meaning of the individual settings are described in Chapter 3.2.3.

3.2.5.1 Display of counter increment (flow value)

The entries of the measurement period archive can be called into the display. Here the increments of the counters in comparison to the corresponding previous entry are also included. They are identified with a " Δ ". Normally, with a counter increment the flow (consumption) within a measurement period is involved.

This is not the case when an archive row has been entered due to a special event (e.g. setting of the clock or of a counter, appearance of an important status message). Then the segment " Δ " and the abbreviated designation flash for the displayed counter increment in order to make the user aware of this special feature.

With an error within an archive row (detected by the CRC procedure) the complete flow value flashes. If for some reason no consumption can be determined, an appropriate error message is issued. In both of the latter cases the displayed value may not be used for billing purposes.

3.2.5.2 Calling up archive entries

Since the measurement period archive may have up to 11500 entries, an entry that is to be checked cannot be reasonably accessed with the cursor keys. The check is made easier using a "skip function" with the entry of the desired destination address in the following columns:

- Block number
- Date and time
- Counter reading

The entry takes place initially by selecting the desired column (block number, date/time or counter reading) in any row. Then the "ENTER" key is pressed to enable entry of the desired value. Then by terminating again with "ENTER" skipping takes place to the desired value or to the nearest possible value. If the desired value is not present at all, skipping occurs to the "nearest" value. If you are located in a "wrong" column in which the skip function is not possible, the message "8" is output.

3.2.6 Application as high flow display device

With the function "High flow display device" the end-readings from both counters relevant for billing and the maxima (measurement period and day maxima) formed in the DL210 are included in the **month archive** of Input 1.

The counter increments per measurement period and per day are determined separately as the measurement period flow and day flow and are temporarily saved. The current and last saved values can be called up via the DL210 display. At the end of each month the counter reading and the highest of these two flow values for the input are saved in the corresponding month archive. The month archive has a depth of 15 entries so that the maximum measurement period and daily flow of the last 15 months can be called up on the display.

The values of the month archive can only be cleared with the calibration lock open and can therefore be used for billing purposes.

The calibrated counters (V1 and V2) and the adjustable counters (V1.A and V2.A) are saved in the archive. Consequently, both counters are available for billing.

The following values are in the archive, calibrated or uncalibrated:

ABNo	Date/ time	V1	V1.A	V1M.L max	Date/ time	Stat	V1D.L max	Date/ time	Stat	ST.1	St.Sy	Check
-	calib'd.	calib'd.	un-calib'd	calib'd.	calib'd.	un-calib'd	calib'd.	calib'd.	un-calib'd	un-calib'd	un-calib'd	-

The meanings of the individual settings are described in Chapter 3.2.2.

The maximum consumption within the measurement period from the last month is given in "**V1M.Lmax**" or the day maximum from the last month is given in "**V1D.Lmax**" and each is derived from the **calibrated main counter** of Input 1. Settings of counters via the keypad or interface are neutralised for the formation of the consumption values and therefore also have no influence over the maxima.

3.2.7 System interface

In the following the relationship between the archives and the necessary settings for the correct processing of the archives in the Elster-Instromet WinVIEW evaluation software is explained.

① The DL210 has one input which can be configured as a counting input.

This means that a max. of one customer or one counter can be connected to the DL210.

For example, "3221234" (②) is taken as the serial number.

The input has one month archive (③), one measurement period archive (④) and one day value archive (⑤). The month archive cannot currently be processed by WinVIEW, because this archive only contains the month-end reading and no consumption data.

As already described in Chaps. 3.2.2 and 3.2.3, two different counters (Counters "a" and "b") can be saved in

each of the two archives. These are set in the DL210 as default at the factory with the main counter "V1" and the adjustable counter "V1.A". Since the evaluation software must differentiate between the two counters, each counter is unambiguously identified based on the above DS-100 number (⑥).

Consequently, each counter can be clearly assigned in the evaluation based on the customer number, meter number and the DS-100 number.

☞ **To prevent a "counter" that is not required from being processed in WinVIEW, the associated DS-100 number must be set to "0".**

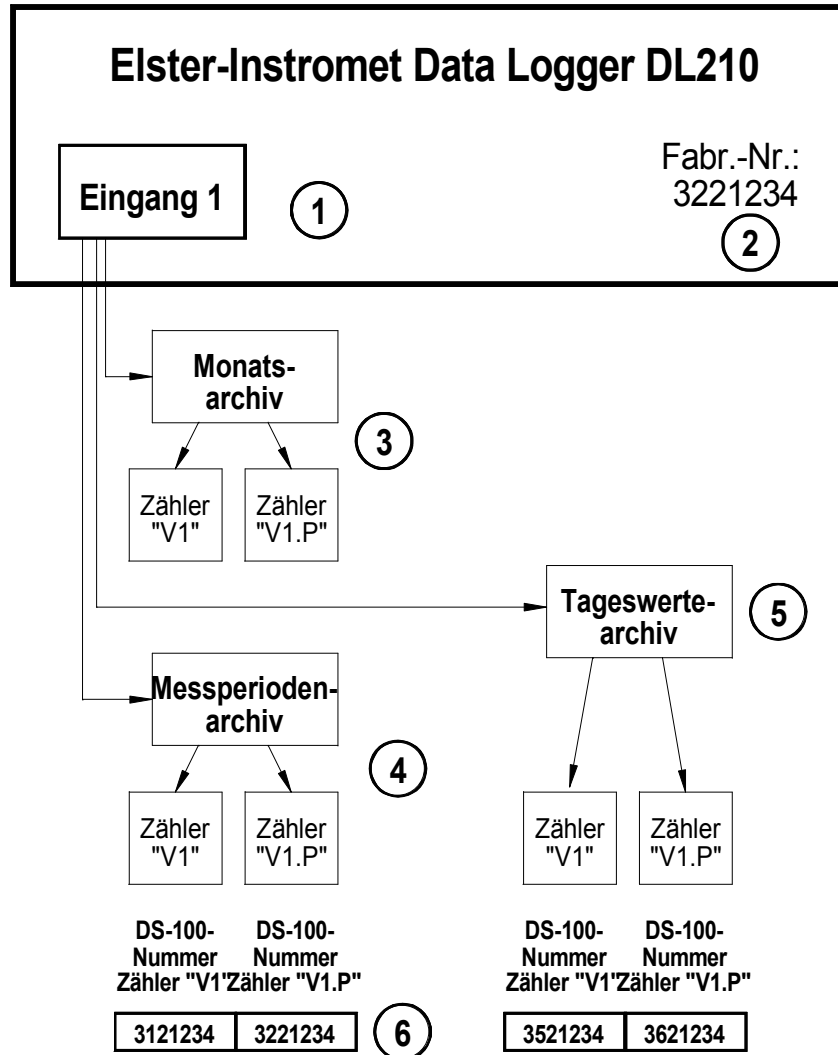

In the following the above mentioned relationships are listed with reference to the representation in the DL210, in the AS-200 and in WinPADS or WinCOMS software.

Input	DL210 display	Archive no. ¹	Designation	Archive content	Counters	DS-100 number ²
I1	ArMo1	1	Month archive	Month-end reading of the calibrated and adjustable counters, and measurement period and day maxima	V1	-
					V1.A	-
	ArMP1	2	Measurement period archive	Counter reading of the calibrated counter and the adjustable counters	V1	3121234
					V1.A	3221234
	ArDy1	13	Day value archive	Day-end reading of the calibrated and adjustable counters.	V1	3521234
					V1.A	3621234
-	Logb.	10	Logbook	Status messages	-	-
-	AudTr	11	Changes archive	Change of parameters	-	-
-	PLogb	12	PTB logbook	Parameters changed with the calibration lock closed and the supplier's lock open	-	-

Explanation:

The column "**DL210 display**" is used in the DL210 display.

The "**Archive number**" is needed for reading out using the AS-200.

The "**Designation**" corresponds to details in WinPADS and WinCOMS.

The "**DS-100 number**" is mandatory for evaluation with WinVIEW and has an appropriate ex-works default value.

☞ **To prevent a "counter" that is not required from being processed in WinVIEW, the DS-100 number must be set to "0".**

¹ Also for AS-200.

² Example based on the DL210 serial number: 3221234.

3.2.8 Reading out archives

There are a number of ways of reading out the above mentioned archives in the DL210:

- AS-200/S2 (from version **V8.4**) on site. At the time of printing this operating manual the day value archive of the DL210 cannot yet be read out!
- PDA on site; obtain further information from Elster-Instromet.
- WinPADS parameterisation software for DL200 series with optical readout head, via remote data transfer or via Ethernet (from version **V2.70**)
- Manual recall via the WinCOMS PC readout software (from version **V2.14**).
- Automatic, time-controlled recall via the WinCOMS control station software.
- Via third-party system / tracing system via MDE or via remote data transmission according to IEC 1107.

3.2.8.1 Readout parties

In the DL210 the following four different readout parties can be defined:

Readout party	Access as	Readout mode adjustable under	Notes for archive
Supplier	Supplier	1:B02	Month archive Input 1
		2:B02	Measurement period archive Input 1
		13:B02	Day value archive Input 1
		10:B02	Logbook
		1:B02	Audit trail
		12:B02	PTB logbook
Customer	Customer	1:B03	Month archive Input 1
		2:B03	Measurement period archive Input 1
		13:B03	Day value archive Input 1
		10:B03	Logbook
		11:B03	Audit trail
		12:B03	PTB logbook
Maintenance	Supplier	1:B04	Month archive Input 1
		2:B04	Measurement period archive Input 1
		13:B04	Day value archive Input 1
		10:B04	Logbook
		11:B04	Audit trail
		12:B04	PTB logbook
Network operator	Customer	1:B05	Month archive Input 1
		2:B05	Measurement period archive Input 1
		13:B05	Day value archive Input 1
		10:B05	Logbook
		11:B05	Audit trail
		12:B05	PTB logbook

Each of the above parties can read out the archives completely independently of the other readout parties. Also, each party can specify which archives can be read out and how they can be read out:

Readout mode	Meaning
0	Archive not read out
1	Read out up to the last readout
2	Only read out previous month
3	Read out previous month up to today
4	Complete readout

Example:

The "supplier" only wants to read out the "measurement period archive" of Input 1 "up to the last readout", not the others. This produces the following settings.

01:B02 (0) Month archive I1, Logbook
 10:B02 (0) 11:B02 (0) and "*do not read out*" audit trail

02:B02 (1) Measurement period archive Input 1
 read out "*up to last read-out*"

These settings can be conveniently set with WinPADS.

It should be noted that the above readout modes are only considered by the Elster-Instromet AS-200 Readout Unit and the WinCOMS evaluation software when in the "**automatic mode**". During manual operation or when reading out the archives with WinPADS for the DL200 series all archives can be read out, also in other modes where applicable.

3.2.8.2 Reading out with the AS-200

The DL210 archives can be read out in various ways with the AS-200/S2 (from version V8.4):

- Automatic - Use the readout notes given in Chap. 3.2.8.1.
- Preset - Here the noted values in the DL210 are NOT used and a readout based on the setting in the AS-200 is carried out.
- Manually - Manual input of which archive is to be read out and in which time period.

In order that a readout can be carried out based on the readout notes, these must first be set in the DL210. This can be done easily with WinPADS for the DL200 series or with the AS-200. Here is defined whether an appropriate archive is to be read out and in which time period. If these are correctly set, a "fully automatic correct" readout of the DL210 is ensured independent of the number of inputs used.

3.2.8.3 Reading out under WinPADS for the DL200 series

On reading out with the WinPADS PC software for the DL200 series (from version V2.70), the DL210 archives can with be read out on site using the optical interface or by remote data transfer. In this respect there is also the option of reading out the archives based on the readout notes. In addition, desired time periods and a readout of all archives can be carried out with WinPADS for the DL200, even if they are deactivated.

3.2.8.4 Reading out with WinCOMS

The program "WinCOMS" combines both methods of reading out, i.e. automatically based on the readout notes and by targeted selection of the appropriate archives. It also offers the possibility of selecting a device and reading it out via remote data transmission (manual selection of the required device) or for the fully automatic recall by a scheduler (time control) which can execute any jobs at set points in time.

In order that an automatic readout can be carried out based on the readout notes, these must first be set in the DL210. This can be done easily with WinPADS for the DL200 series or, with restriction, the AS-200. Here is defined whether an appropriate archive is to be read out and in which time period. If they are correctly set, a "fully automatic" readout of the DL210 is ensured.

3.2.8.5 Reading out with 3rd party systems / follow-on systems

Since the data and therefore also the archives are interrogated via the internationally standardised IEC 1107 protocol, it is possible to link the DL210 to "3rd party or "follow-on systems" very easily.

Information about which 3rd party systems can read out from the DL220 can be obtained on request from Elster-Instromet GmbH. Also, a summary of the requirements placed on 3rd party/follow-on systems for reading out the LIS-200 devices can be obtained from Elster-Instromet.

3.3 Status list

Name	Address	Designation / value	Explanation	Access	DC
S.Reg	1:101	Status register	Display of the status register and skip to the menu: "Status register"	-	11
Stat	1:100	Momentary status	Display of the momentary status and skip to the menu: "Momentary status"	-	11
Clr	4:130	Clear status register		S	6
Logb.	10:A30	Logbook	Skip to archive: "Logbook"	-	10
AudTr	11:A30	Changes archive	Skip to archive: "Audit trail"	-	10
PLogb	12:A30	PTB logbook	Skip to archive: "PTB logbook"	-	10
ClrPL	12:A52	Clear PTB logbook	Clear the "PTB logbook"	P	6

DC = Data class (for description see Chap. 2.5.1, page 25.)

P/PL/S/C = The displayed value is subject to: "**P**": Calibration lock "**PL**": PTB logbook "**S**": Supplier's lock "**C**": Customer's lock "-": Value cannot be changed..

3.3.1 Description of the values

S.Reg Status register

In this status display all group status messages which have occurred in the DL210 since the last deletion are displayed in the form of message number(s). If they are no longer applied, they can be cleared under "Clr" (see below). For the display of the individual status messages this display item is also realised as a method of entry into a **submenu** for further messages (see submenu Status register). Here the messages are displayed plain text.

Stat Momentary status

Here all the currently applied group messages (momentary status) are displayed. The display can be updated by pressing "ENTER", as for measurements. Deletion here is not possible!

For the display of the individual status messages this display item is also realised as a method of entry into a **submenu** for further messages (see submenu Momentary status). Here the messages are displayed plain text.

Clr Clear status

The status register can be cleared under this menu point (see Chap. 3.3.12). If messages are still current, then they are recorded again directly.

Logb. Logbook

Branching to the logbook can be carried out under this display using ENTER.

AudTr Changes archive (audit trail)

The displayed value is used as a method of entering the changes archive. Here, all changes are saved which have been made to the device programming.

PLogb PTB logbook



The PTB logbook contains the values which have been changed with the calibration lock closed and the supplier's lock open.

☞ **If the PTB logbook is full, these values can only be changed with the calibration lock open. An open calibration lock can only be closed when the PTB logbook is not full. This must be cleared if necessary before closing the calibration lock.**



ClrPL Clear PTB logbook



The PTB logbook can be cleared under this menu item with the calibration lock open.

3.3.2 Submenu: Status register

Under "SReg" skipping into the submenu: "Status register" can be made with "ENTER" (press arrow keys  and  simultaneously). Here, all prior (past) messages are displayed which however have not been acknowledged.



The message number, an abbreviation of the message in plain text and the corresponding entity which has generated the message are given.

The key  can be used to branch to any other applied messages or the arrow key  to the previous message.



The status register can be quit with "ESC" (press arrow keys  and  simultaneously).



Explanation of the messages: see Chap.: 3.3.9.

3.3.3 Submenu: Momentary status

Under "STAT" skipping into the submenu: "Momentary status" can be made with "ENTER" (press arrow keys  and  simultaneously). There, only the messages of the system and entities 1 ..4 which are currently valid are saved (e.g.: inputs 1 - 2).

The message number, an abbreviation of the message in plain text and the corresponding entity which has generated the message are given.

The key  can be used to branch to any other applied messages or the arrow key  to the previous message.

The momentary status can be quit again with "ESC" (press arrow keys  and  simultaneously).

Explanation of the messages: see Chap.: 3.3.9.

3.3.4 Submenu: Logbook

The logbook is a chronological listing of all events which can occur in the DL210. Each change leads to a corresponding entry in the logbook:

- Signal "arrives" Display "↑"
- Signal "goes" Display "↓"

The structure is as follows:

Data record no.	ABNo	Time (time of day)	Time (date)	Ev (event)	Check
1	4711	12:00:00	16.02.2004	Supp.lock o.↑	OK
2	4712	12:15:22	16.02.2004	online ↓	OK
3	4713	12:17:53	16.02.2004	online ↑	OK

Description of the displayed values in the logbook:

ABNo Internal archive block number

This is a number (constant from 1 to 65535) which is used as a label for **one** data record (corresponds to one row) in the archive. For the first time of saving the block number 1 is issued, then 2 etc. up to 65535. After an overflow counting starts from "0".

Time Time

Storage time of the data record in the corresponding "archive row".

Time Date

Storage date of the data record in the corresponding "archive row".

Ev Triggering event

Event which causes the saving of this data record (structure: See Chap. 3.3.13).

Check Checksum evaluation

Display of whether the data row is correct (OK) or faulty (ERROR).

3.3.5 Submenu: Changes archive (audit trail)

The changes archive (termed "Audit trail" at Elster-Instromet) contains the last 200 changes made in the device. This includes parameter changes and also opening and closing the locks. The value before (old = "a") and after the change (new = "n") is retained as well as the status of the locks and date/time of the change:

Data record no.	ABNo	Time (time of day)	Time (date)	Addr (Address)	a	n
1	4711	12:00:00	16.02.2004	0004:B04_0	0	3
2	4712	12:15:22	16.02.2004	"Md.I1"	1	1
3	4713	12:17:53	16.02.2004	"CP.I1"	1	10
...						

Data record no.	St.PL	St.ML	St.SL	St.CL	Check
1	1	0	1	1	OK
2	1	0	1	1	OK
3	0	0	1	1	OK
...					

3.3.6 Submenu: PTB logbook

The PTB logbook contains the last 50 changes made to parameters which are subject to the access right "PL" (see Functional description, operating lists, Chapter 3). Changes to these parameters may only be carried out with the supplier's lock open. Changes made with the calibration lock open are not considered in the PTB logbook. If the PTB logbook is full, the parameters subject to the access right "PL" can only be changed with the calibration lock open. Clearing the PTB logbook can also only occur with the calibration lock open.

In the PTB logbook the value before (old = "a") and after the change (new = "n"), as well as the states of the locks and appropriate information about the date and time of the change are retained:

Data record no.	ABNo	Time (time of day)	Time (date)	Addr (Address)	a	n
1	4711	13:00:00	16.02.2004	"MP.I1"	60	10
2	4712	13:15:22	16.02.2004	"Md.I1"	1	5
3	4713	13:17:53	16.02.2004	"CP.I1"	1	10
...						

Data record no.	St.PL	St.ML	St.SL	St.CL	Check
1	0	0	1	0	OK
2	0	0	1	0	OK
3	0	0	1	0	OK
...					

3.3.7 Description of values shown in the audit trail and PTB logbook

ABNo	Internal archive block number This is a number (constant from 1 to 65535) which is used as a label for one data record (corresponds to one row) in the archive. For the first time of saving the block number 1 is issued, then 2 etc. up to 65535. After an overflow counting starts from "1" again.
Time	Time Storage time of the data record in the corresponding "archive row".
Time	Date Storage date of the data record in the corresponding "archive row".
Add	Address of the changed value Display of the address or the short designation of the changed value
a	Old value The original valid value before the change.
n	New value The changed value which is now valid.
St.PL	Status of calibration lock The status of the calibration lock during the change.
St.ML	Status of manufacturer's lock The status of the manufacturer's lock during the change.
St.SL	Status of supplier's lock The status of the supplier's lock during the change.
St.CL	Status of customer's lock The status of the customer's lock during the change.
Check	Checksum of the data row Indicates whether the archive row has been correctly saved.

3.3.8 The status register

3.3.8.1 Types of message

A differentiation is made between four types of message:

Alarm	is used in the DL210 for "Restart" and in the encoder mode.
Warning	affects all signals which are so important that the user must be informed about the signal and must therefore acknowledge it.
Report	is less "important" than "Warning" and does not therefore need acknowledging.
Information	is only needed for internal functions for the labelling of operating states (usually time modes).

3.3.8.2 Status register and momentary status

The status display in the DL210 is subdivided into two ranges: One is the "**momentary status**" which contains only the current messages. The messages: Alarm, Warning and Report are entered in this register. If the cause of a message is no longer active, it is automatically deleted from this register. This means that a quick overview of the current operating states is possible.

The second register, designated the "**status register**", contains all active and passed messages (alarms and warnings) which have not yet been acknowledged. There is then the possibility of being able to check messages that have already passed.

3.3.9 Summary of message numbers

Momentary status		Stat	St.Sy	St.1	St.2	St.3	St.4
Status register		S.Reg	SR.Sy	SR.1	SR.2	SR.3	SR.4
No.	Type ¹	Group message	System message	Status 1	Status 2	Status 3	Status 4
01	A	Any message 01	Restart	Enc.Plaus.	-	-	-
02	A	-	-	Enc.Error	-	-	-
03	W	Any message 03	Data restore	-	-	-	-
04	W	Any message 04	-	-	-	-	-
05	W	Any message 05	-	-	-	-	-
06	W	Any message 06	-	I1 Warn Lim.	I2 Warn Lim.	-	-
07	W	Any message 07	-	-	-	-	-
08	W	Any message 08	Sett. error	I1 Warn.sig.	I2 Warn.sig.	-	-
09	R	Any message 09	Batt. low	-	-	-	Batt2 low
10	R	Any message 10	-	-	-	-	-
11	R	Any message 11	Clock n. set	-	-	-	-
12	R	Any message 12	-	Lim. I1	Lim. I2	-	-
13	R	Any message 13	online	RepSig.I1	Rep.Sig.I2	-	-
14	R	Any message 14	-	Cal.lock o.	Man.lock o.	Suppl. lock	Cust. lock
15	I	Any message 15	Batt. operat	-	-	-	-
16	I	Any message 16	Daylight saving	Call Win.1	Call Win.2	Call Win.3	Call Win.4

¹ A = Alarm; W = Warning; R = Report; I = Information

3.3.10 Explanation of the messages

Code	Plain text display	Type ¹	Description
Group message			
-	Group message	-	Summary of all messages (System, Status1, Status2, Status3 and Status4) in the form of status register S.Reg or momentary status Stat in the main menu. Example: Under "04" all "04" messages of the statuses St.Sy, Sr.Sy, St.1, Sr.1, ..., Sr.4 are summarised. If one or more "04" messages occurs, the group message "04" becomes active.
System messages			
01	Restart	A	During run-up no correct data was detected in the RAM and the DL210 starts with default values. Then all parameters are read from the E ² PROM. The date/time and meter readings however do not correspond to the actual status, but instead to the last saving to E ² PROM (written once each day at about 00:00 hrs.).
02	-	-	-
03	Data restore	W	The date/time had to be read back out of the E ² PROM, because, for example, the battery was discharged. The difference to the current time corresponds to the duration of the power failure.
04	-	-	-
05	-	-	-
06	-	-	-
07	-	-	-
08	Sett. error	W	On account of the programming an unprocessable combination of data arose, e.g. a data type which is not acceptable in a certain mode.
09	Batt. low	W	The notice appears when the remaining battery service life computed by the DL210 has fallen below the limit of 3.0 months.
10	-	-	-
11	Clock n. set	R	The correction factors needed for the internal clock are not correct or have not yet been entered.
12	-	-	-
13	online	R	A data transmission (e.g. via modem) is currently active.
14	-	-	-
15	Batt. operat	I	Device is currently in the battery mode.
16	Daylight saving	I	The display of the time occurs in summer time (CEST).

¹ A = Alarm; W = Warning; R = Report; I = Information

Status messages Status 1, Status 2, Status 3 und Status 4			
01	Enc.Plaus.	A	The set encoder flow rate has been exceeded.
02	Enc.Error	A	The connected encoder is not supplying any data.
03	-	-	-
04	-	-	-
05	-	-	-
06	I1 Warn Lim. I2 Warn Lim.	W	A set warning limit on Input I1...2 has been violated.
07	-	-	-
08	I1 Warn.sig. I2 Warn.sig.	W	The warning signal was active on status input I1...2 (e.g. manipulation detection, volume corrector alarm).
09	Batt2 low	R	The modem battery voltage has dropped below the permissible value. The modem battery should be replaced.
10	-	-	-
11	-	-	-
12	Lim. Input 1 Lim. Input 2	R	The limit set for monitoring on Input I1...2 (e.g. for measurement period or daily consumption) has been exceeded.
13	RepSig.I1 RepSig.I2	W	The report signal is active on status input I1...2.
14	Cal. lock o. Man. lock o. Suppl. lock o. Cust. lock o.	R	Lock open (Message in St.1=calibration lock, in St.2 = Manufacturer's lock, in St.3 = supplier's lock, in St.4 = customer's lock).
15	-	-	-
16	Call Win.1 Call Win2 Call Win3 Call Win4	I	Call window 1...4 is currently open.

3.3.12 Clearing an alarm or a warning

The clearing of all past (!) messages in the status register S.Reg occurs in the list "Status" under the display: "Clr". Clearing messages is only possible with an open calibration, manufacturer's or supplier's lock.

After calling by ENTER, an "0" is positioned right-justified in the display. The function is triggered, i.e. all status registers are cleared, after switching to "1" with ↑ or ↓ and terminating with ENTER.

If messages are currently present, then they are recorded again directly after a clear. The deleted messages can still be called in the logbook.

Example:

Once the message is recognised (see previous chapter), it should also be cleared.

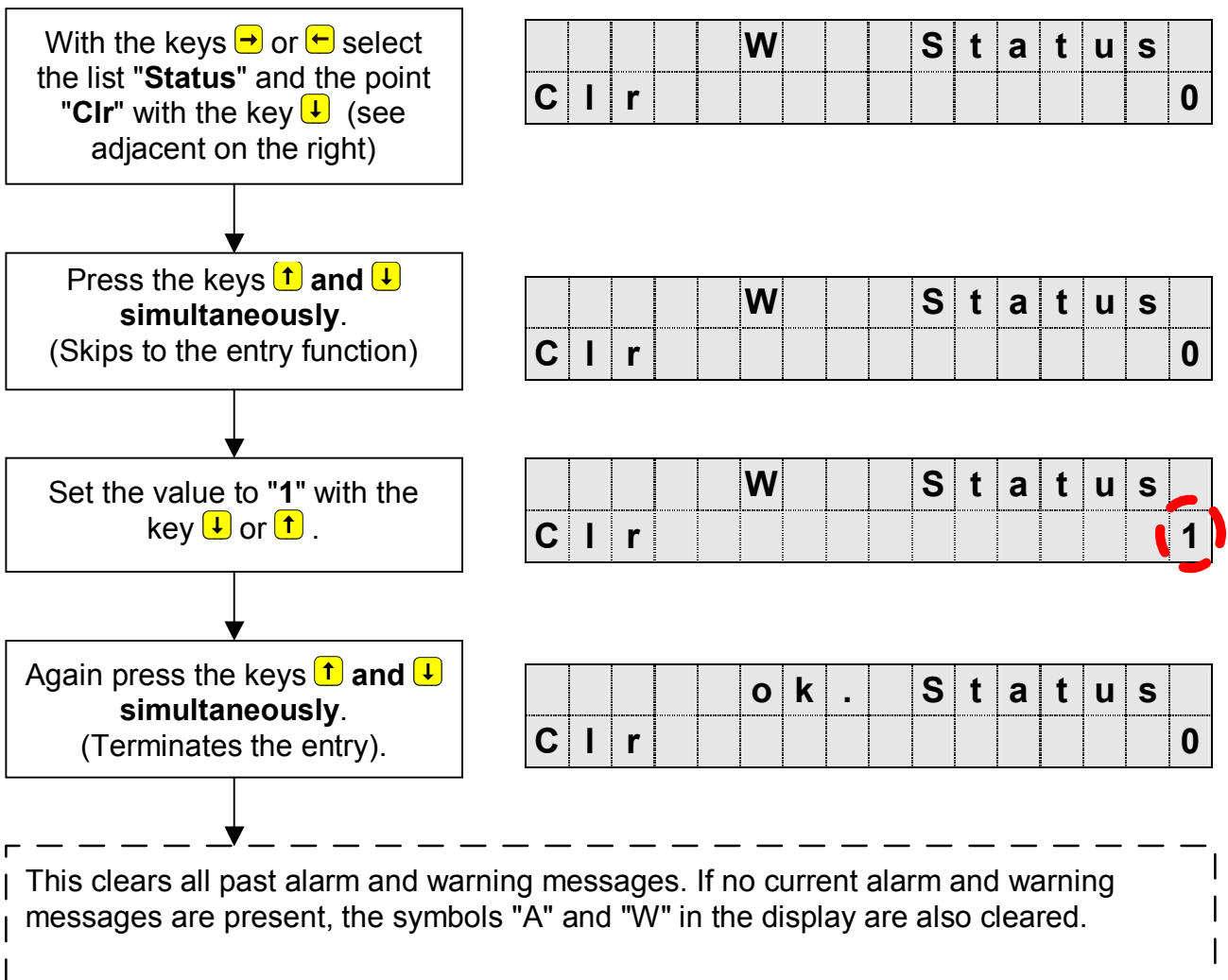

3.3.13 Events in the DL210

Exactly one triggering event exists for each saved data record. An event may be, for example:

- the change in a single signal in the momentary status; e.g. "Warning signal on Status Input 1 starts",
- the change in at least one of a defined number of signals (signal group); e.g. "Warning starts", "Warning ends",
- an event which occurs outside of the momentary status; e.g. "month limit" or "meter reading set",
- manual triggering of data backup using "Save" in the service list.

The individual columns in the following table have the following meaning:

- **Display:** Plain text of status messages and events in the DL210 display.
- **Event:** Name of the triggering event.
- **Keypad entry:** These values can be entered via the keypad to, for example, program the behaviour of an output.
- **Interface:** After reading out the archives these values are located in the corresponding archive files and are needed for parameterisation.
- **Description:** Explanation of the factory-set events.

3.3.13.1 Summary of all events and their meaning

Display	Event	Keypad entry	Interface	Description	
Individual messages in the status registers ST.1 – ST.4					
Enc.Plaus.↓	Message 1 in St.1	01_01:1.0	0001	I1: Encoder flow rate exceeded	ends
Enc.Plaus.↑		01_01:1.1	2001		starts
Enc.Error ↓	Message 2 in St.1	02_01:1.0	0101	I1: Encoder error	ends
Enc.Error ↑		02_01:1.1	2101		starts
Warn lim.I1↓	Message 6 in St.1	06_01:1.0	0501	I1: Warning limit violated	ends
Warn lim.I1↑		06_01:1.1	2501		starts
Warn lim.I2↓	Message 6 in St.2	06_02:1.0	0502	I2: Warning limit violated	ends
Warn lim.I2↑		06_02:1.1	2502		starts
Warn.sigI1↓	Message 8 in St.1	08_01:1.0	0701	I1: Warning signal active	ends
Warn.sigI1↑		08_01:1.1	2701		starts
Warn.sigI2↓	Message 8 in St.2	08_02:1.0	0702	I2: Warning signal active	ends
Warn.sigI2↑		08_02:1.1	2702		starts
Batt2Warn.↓	Message 9 in St.4	09_04:1.0	0804	Modem battery warning	ends
Batt2Warn.↑		09_04:1.1	2804		starts
Limit.I1↓	Message 12 in St.1	12_01:1.0	0B01	I1: Limit violated	ends
Limit.I1↑		12_01:1.1	2B01		starts

Display	Event	Keypad entry	Interface	Description	
Limit.I2↓	Message 12 in St.2	12_02:1.0	0B02	I2: Limit violated	ends
Limit.I2↑		12_02:1.1	2B02		starts
RepSig.I1↓	Message 13 in St.1	13_01:1.0	0C01	I1: Report signal active	ends
RepSig.I1↑		13_01:1.1	2C01		starts
RepSig.I2↓	Message 13 in St.2	13_02:1.0	0C02	I2: Report signal active	ends
RepSig.I2↑		13_02:1.1	2C02		starts
Cal.lock o.↓	Message 14 in St.1	14_01:1.0	0D01	Calibration lock open	ends
Cal.lock o.↑		14_01:1.1	2D01		starts
Man.lock o.↓	Message 14 in St.2	14_02:1.0	0D02	Manufacturer's lock open	ends
Man.lock o.↑		14_02:1.1	2D02		starts
Supp.lock o.↓	Message 14 in St.3	14_03:1.0	0D03	Supplier's lock open	ends
Supp.lock o.↑		14_03:1.1	2D03		starts
Cust.lock o.↓	Message 14 in St.4	14_04:1.0	0D04	Customer's lock open	ends
Cust.lock o.↑		14_04:1.1	2D04		starts
Call Win1↓	Message 16 in St.1	16_01:1.0	0F01	Call Window 1	ends
Call Win1↑		16_01:1.1	2F01		starts
Call Win2↓	Message 16 in St.2	16_02:1.0	0F02	Call Window 2	ends
Call Win2↑		16_02:1.1	2F02		starts
Call Win3↓	Message 16 in St.3	16_03:1.0	0F03	Call Window 3	ends
Call Win3↑		16_03:1.1	2F03		starts
Call Win4↓	Message 16 in St.4	16_04:1.0	0F04	Call Window 4	ends
Call Win4↑		16_04:1.1	2F04		starts
System messages in the status register St.Sy					
Restart↓	Message 1 in St.Sy	01_02:2.0	1002	Restart	ends
Restart↑		01_02:2.1	3002		starts
Dat.restore↓	Message 3 in St.Sy	03_02:2.0	1202	Data restored	ends
Dat.restore ↑		03_02:2.1	3202		starts
Sett. error↓	Message 8 in St.Sy	08_02:2.0	1702	Settings fault	ends
Sett. error↑		08_02:2.1	3702		starts
Batt. low↓	Message 9 in St.Sy	09_02:2.0	1802	Battery warning	ends
Batt. low↑		09_02:2.1	3802		starts
Clock n. set↓	Message 11 in St.Sy	11_02:2.0	1A02	Clock not set	ends
Clock n. set↑		11_02:2.1	3A02		starts
online↓	Message 13 in St.Sy	13_02:2.0	1C02	Data transmission running	ends
online↑		13_02:2.1	3C02		starts
Batt. operat.↓	Message 15 in St.Sy	15_02:2.0	1E02	Battery operation	ends
Batt. operat.↑		15_02:2.1	3E02		starts
Dayl.Sav.Tim↓	Message 16 in St.Sy	16_02:2.0	1F02	Summer time	ends
Dayl.Sav.Tim↑		16_02:2.1	3F02		starts

Display	Event	Keypad entry	Interface	Description	
Group messages of all single and system messages (St.Sy, St.1, St.2, St.3, St.4)					
Message1↓	Message 1 in Stat	01_01:2.0	1001	Any	ends
Message1↑		01_01:2.1	3001	Status message 1	starts
Message2↓	Message 2 in Stat	02_01:2.0	1101	Any	ends
Message2↑		02_01:2.1	3101	Status message 2	starts
Message3↓	Message 3 in Stat	03_01:2.0	1201	Any	ends
Message3↑		03_01:2.1	3201	Status message 3	starts
Message4↓	Message 4 in Stat	04_01:2.0	1301	Any	ends
Message4↑		04_01:2.1	3301	Status message 4	starts
Message5↓	Message 5 in Stat	05_01:2.0	1401	Any	ends
Message5↑		05_01:2.1	3401	Status message 5	starts
Message6↓	Message 6 in Stat	06_01:2.0	1501	Any	ends
Message6↑		06_01:2.1	3501	Status message 6	starts
Message7↓	Message 7 in Stat	07_01:2.0	1601	Any	ends
Message7↑		07_01:2.1	3601	Status message 7	starts
Message8↓	Message 8 in Stat	08_01:2.0	1701	Any	ends
Message8↑		08_01:2.1	3701	Status message 8	starts
Message9↓	Message 9 in Stat	09_01:2.0	1801	Any	ends
Message9↑		09_01:2.1	3801	Status message 9	starts
Message10↓	Message 10 in Stat	10_01:2.0	1901	Any	ends
Message10↑		10_01:2.1	3901	Status message 10	starts
Message11↓	Message 11 in Stat	11_01:2.0	1A01	Any	ends
Message11↑		11_01:2.1	3A01	Status message 11	starts
Message12↓	Message 12 in Stat	12_01:2.0	1B01	Any	ends
Message12↑		12_01:2.1	3B01	Status message 12	starts
Message13↓	Message 13 in Stat	13_01:2.0	1C01	Any	ends
Message13↑		13_01:2.1	3C01	Status message 13	starts
Message14↓	Message 14 in Stat	14_01:2.0	1D01	Any	ends
Message14↑		14_01:2.1	3D01	Status message 14	starts
Message15↓	Message 15 in Stat	15_01:2.0	1E01	Any	ends
Message15↑		15_01:2.1	3E01	Status message 15	starts
Message16↓	Message 16 in Stat	16_01:2.0	1F01	Any	ends
Message16↑		16_01:2.1	3F01	Status message 16	starts
Message groups of the status registers ST.1 - ST.4					
ST.1:M1-4↓	Message 1-4 in St.1	1,04_01:1.0	4301	Any message between 1 and 4 in St.1	ends
ST.1:M1-4↑		1,04_01:1.1	6301		starts
ST.2:M1-4↓	Message 1-4 in St.2	1,04_02:1.0	4302	Any message between 1 and 4 in St.2	ends
ST.2:M1-4↑		1,04_02:1.1	6302		starts

Display	Event	Keypad entry	Interface	Description	
ST.1:M1-5↓	Message 1-5 in St.1	1,05_01:1.0	4401	Any message between 1 and 5 in St.1	ends
ST.1:M1-5↑		1,05_01:1.1	6401		starts
ST.2:M1-5↓	Message 1-5 in St.2	1,05_02:1.0	4402	Any message between 1 and 5 in St.2	ends
ST.2:M1-5↑		1,05_02:1.1	6402		starts
ST.3:M1-5↓	Message 1-5 in St.3	1,05_03:1.0	4403	Any message between 1 and 5 in St.3	ends
ST.3:M1-5↑		1,05_03:1.1	6403		starts
ST.4:M1-5↓	Message 1-5 in St.4	1,05_04:1.0	4404	Any message between 1 and 5 in St.4	ends
ST.4:M1-5↑		1,05_04:1.1	6404		starts
ST.1:M1-6↓	Message 1-6 in St.1	1,06_01:1.0	4501	Any message between 1 and 6 in St.1	ends
ST.1:M1-6↑		1,06_01:1.1	6501		starts
ST.2:M1-6↓	Message 1-6 in St.2	1,06_02:1.0	4502	Any message between 1 and 6 in St.2	ends
ST.2:M1-6↑		1,06_02:1.1	6502		starts
ST.3:M1-6↓	Message 1-6 in St.3	1,06_03:1.0	4503	Any message between 1 and 6 in St.3	ends
ST.3:M1-6↑		1,06_03:1.1	6503		starts
ST.4:M1-6↓	Message 1-6 in St.4	1,06_04:1.0	4504	Any message between 1 and 6 in St.4	ends
ST.4:M1-6↑		1,06_04:1.1	6504		starts
ST.1:M1-7↓	Message 1-7 in St.1	1,07_01:1.0	4601	Any message between 1 and 7 in St.1	ends
ST.1:M1-7↑		1,07_01:1.1	6601		starts
ST.1:M1-8↓	Message 1-8 in St.1	1,08_01:1.0	4701	Any message between 1 and 8 in St.1	ends
ST.1:M1-8↑		1,08_01:1.1	6701		starts
ST.2:M1-8↓	Message 1-8 in St.2	1,08_02:1.0	4702	Any message between 1 and 8 in St.2	ends
ST.2:M1-8↑		1,08_02:1.1	6702		starts
ST.3:M1-8↓	Message 1-8 in St.3	1,08_03:1.0	4703	Any message between 1 and 8 in St.3	ends
ST.3:M1-8↑		1,08_03:1.1	6703		starts
ST.4:M1-8↓	Message 1-8 in St.4	1,08_04:1.0	4704	Any message between 1 and 8 in St.4	ends
ST.4:M1-8↑		1,08_04:1.1	6704		starts
ST.1:M1-12↓	Message 1-12 in St.1	1,12_01:1.0	4701	Any message between 1 and 12 in St.1	ends
ST.1:M1-12↑		1,12_01:1.1	6B01		starts
ST.2:M1-12↓	Message 1-12 in St.2	1,12_02:1.0	4B02	Any message between 1 and 12 in St.2	ends
ST.2:M1-12↑		1,12_02:1.1	6B02		starts
ST.3:M1-12↓	Message 1-12 in St.3	1,12_03:1.0	4B03	Any message between 1 and 12 in St.3	ends
ST.3:M1-12↑		1,12_03:1.1	6B03		starts
ST.4:M1-12↓	Message 1-12 in St.4	1,12_04:1.0	4B04	Any message between 1 and 12 in St.4	ends
ST.4:M1-12↑		1,12_04:1.1	6B04		starts
ST.1:M1-13↓	Message 1-13 in St.1	1,13_01:1.0	4C01	Any message between 1 and 13 in St.1	ends
ST.1:M1-13↑		1,13_01:1.1	6C01		starts
ST.2:M1-13↓	Message 1-13 in St.2	1,13_02:1.0	4C02	Any message between 1 and 13 in St.2	ends
ST.2:M1-13↑		1,13_02:1.1	6C02		starts

Display	Event	Keypad entry	Interface	Description	
ST.3:M1-13↓	Message 1-13 in St.3	1,13_03:1.0	4C03	Any message between 1 and 13 in St.3	ends
ST.3:M1-13↑		1,13_03:1.1	6C03		starts
ST.4:M1-13↓	Message 1-13 in St.4	1,13_04:1.0	4C04	Any message between 1 and 13 in St.4	ends
ST.4:M1-13↑		1,13_04:1.1	6C04		starts
ST.1:M1-14↓	Message 1-14 in St.1	1,14_01:1.0	4D01	Any message between 1 and 14 in St.1	ends
ST.1:M1-14↑		1,14_01:1.1	6D01		starts
ST.2:M1-14↓	Message 1-14 in St.2	1,14_02:1.0	4D02	Any message between 1 and 14 in St.2	ends
ST.2:M1-14↑		1,14_02:1.1	6D02		starts
ST.3:M1-14↓	Message 1-14 in St.3	1,14_03:1.0	4D03	Any message between 1 and 14 in St.3	ends
ST.3:M1-14↑		1,14_03:1.1	6D03		starts
ST.4:M1-14↓	Message 1-14 in St.4	1,14_04:1.0	4D04	Any message between 1 and 14 in St.4	ends
ST.4:M1-14↑		1,14_04:1.1	6D04		starts
ST.1:M1-16↓	Message 1-16 in St.1	1,16_01:1.0	4F01	Any message between 1 and 16 in St.1	ends
ST.1:M1-16↑		1,16_01:1.1	6F01		starts
ST.2:M1-16↓	Message 1-16 in St.2	1,16_02:1.0	4F02	Any message between 1 and 16 in St.2	ends
ST.2:M1-16↑		1,16_02:1.1	6F02		starts
ST.3:M1-16↓	Message 1-16 in St.3	1,16_03:1.0	4F03	Any message between 1 and 16 in St.3	ends
ST.3:M1-16↑		1,16_03:1.1	6F03		starts
Message groups of the status register St.Sy					
St.Sy:M1-1↓	Message 1 in St.Sy	1,01_02:2.0	5002	Message 1 in St.Sy	ends
St.Sy:M1-1↑		1,01_02:2.1	7002		starts
St.Sy:M1-3↓	Message 1...3 in St.Sy	1,03_02:2.0	5202	Any message between 1 and 3 in St.Sy	ends
St.Sy:M1-3↑		1,03_02:2.1	7202		starts
St.Sy:M1-4↓	Message 1...4 in St.Sy	1,04_02:2.0	5302	Any message between 1 and 4 in St.Sy	ends
St.Sy:M1-4↑		1,04_02:2.1	7302		starts
St.Sy:M1-5↓	Message 1...5 in St.Sy	1,05_02:2.0	5402	Any message between 1 and 5 in St.Sy	ends
St.Sy:M1-5↑		1,05_02:2.1	7402		starts
St.Sy:M1-6↓	Message 1...6 in St.Sy	1,06_02:2.0	5502	Any message between 1 and 6 in St.Sy	ends
St.Sy:M1-6↑		1,06_02:2.1	7502		starts
St.Sy:M1-7↓	Message 1...7 in St.Sy	1,07_02:2.0	5602	Any message between 1 and 7 in St.Sy	ends
St.Sy:M1-7↑		1,07_02:2.1	7602		starts
St.Sy:M1-8↓	Message 1...8 in St.Sy	1,08_02:2.0	5702	Any message between 1 and 8 in St.Sy	ends
St.Sy:M1-8↑		1,08_02:2.1	7702		starts
St.Sy:M1-9↓	Message 1...9 in St.Sy	1,09_02:2.0	5802	Any message between 1 and 9 in St.Sy	ends
St.Sy:M1-9↑		1,09_02:2.1	7802		starts
St.Sy:M1-10↓	Message 1...10 in St.Sy	1,10_02:2.0	5902	Any message between 1 and 10 in St.Sy	ends
St.Sy:M1-10↑		1,10_02:2.1	7902		starts

Display	Event	Keypad entry	Interface	Description	
St.Sy:M1-11↓	Message	1,11_02:2.0	5A02	Any message between 1 and 11 in St.Sy	ends
St.Sy:M1-11↑	1...11 in St.Sy	1,11_02:2.1	7A02		starts
St.Sy:M1-13↓	Message	1,13_02:2.0	5C02	Any message between 1 and 13 in St.Sy	ends
St.Sy:M1-13↑	1...13 in St.Sy	1,13_02:2.1	7C02		starts
St.Sy:M1-15↓	Message	1,15_02:2.0	5E02	Any message between 1 and 15 in St.Sy	ends
St.Sy:M1-15↑	1...15 in St.Sy	1,15_02:2.1	7E02		starts
St.Sy:M1-16↓	Message	1,16_02:2.0	5F02	Any message between 1 and 16 in St.Sy	ends
St.Sy:M1-16↑	1...16 in St.Sy	1,16_02:2.1	7F02		starts
Message groups of the group messages in Stat					
Stat:M1-1↓	Message 1 in Stat	1,01_01:2.0	5001	Message 1 in Stat	ends
Stat:M1-1↑		1,01_01:2.1	7001		starts
Stat:M1-2↓	Message 1...2 in Stat	1,02_01:2.0	5101	Any message between 1 and 2 in Stat	ends
Stat:M1-2↑		1,02_01:2.1	7101		starts
Stat:M1-3↓	Message 1...3 in Stat	1,03_01:2.0	5201	Any message between 1 and 3 in Stat	ends
Stat:M1-3↑		1,03_01:2.1	7201		starts
Stat:M1-4↓	Message 1...4 in Stat	1,04_01:2.0	5301	Any message between 1 and 4 in Stat	ends
Stat:M1-4↑		1,04_01:2.1	7301		starts
Stat:M1-5↓	Message 1...5 in Stat	1,05_01:2.0	5401	Any message between 1 and 5 in Stat	ends
Stat:M1-5↑		1,05_01:2.1	7401		starts
Stat:M1-6↓	Message 1...6 in Stat	1,06_01:2.0	5501	Any message between 1 and 6 in Stat	ends
Stat:M1-6↑		1,06_01:2.1	7501		starts
Stat:M1-7↓	Message 1...7 in Stat	1,07_01:2.0	5601	Any message between 1 and 7 in Stat	ends
Stat:M1-7↑		1,07_01:2.1	7601		starts
Stat:M1-8↓	Message 1...8 in Stat	1,08_01:2.0	5701	Any message between 1 and 8 in Stat	ends
Stat:M1-8↑		1,08_01:2.1	7701		starts
Stat:M1-9↓	Message 1...9 in Stat	1,09_01:2.0	5801	Any message between 1 and 9 in Stat	ends
Stat:M1-9↑		1,09_01:2.1	7801		starts
Stat:M1-10↓	Message 1...10 in Stat	1,10_01:2.0	5901	Any message between 1 and 10 in Stat	ends
Stat:M1-10↑		1,10_01:2.1	7901		starts
Stat:M1-11↓	Message 1...11 in Stat	1,11_01:2.0	5A01	Any message between 1 and 11 in Stat	ends
Stat:M1-11↑		1,11_01:2.1	7A01		starts
Stat:M1-12↓	Message 1...12 in Stat	1,12_01:2.0	5B01	Any message between 1 and 12 in Stat	ends
Stat:M1-12↑		1,12_01:2.1	7B01		starts
Stat:M1-13↓	Message 1...13 in Stat	1,13_01:2.0	5C01	Any message between 1 and 13 in Stat	ends
Stat:M1-13↑		1,13_01:2.1	7C01		starts
Stat:M1-14↓	Message 1...14 in Stat	1,14_01:2.0	5D01	Any message between 1 and 14 in Stat	ends
Stat:M1-14↑		1,14_01:2.1	7D01		starts
Stat:M1-15↓	Message 1...15 in Stat	1,15_01:2.0	5E01	Any message between 1 and 15 in Stat	ends
Stat:M1-15↑		1,15_01:2.1	7E01		starts

Display	Event	Keypad entry	Interface	Description	
Stat:M1-16↓	Message 1...16 in Stat	1,16_01:2.0	5F01	Any message between 1 and 16 in Stat	ends
Stat:M1-16↑		1,16_01:2.1	7F01		starts

Display	Event	Keypad entry	"Interface"	Description	
Programmed events					
Backup↓	Event 1	-	8001	Backup time	Arose again ¹
Backup↑		-	8101		Arose anew
Time sync. ↓	Event 4	-	8004	Time of clock setting by rem. data transmission	Arose again ¹
Time sync. ↑		-	8104		Arose anew
Meas. per. I1↓	Event 5	-	8005	Measurement period for Input 1	Arose again ¹
Meas. per. I1↑		-	8105		Arose anew
Freeze ↓	Event 9	-	8009	Time for freezing the values for standard interrogation	Arose again ¹
Freeze ↑		-	8109		Arose anew
Monthbdy._I1↓	Event 17	-	8011	Month boundary for Input 1	Arose again ¹
Monthbdy._I1↑		-	8111		Arose anew
Daybdy._I1↓	Event 21	-	8015	Day boundary for Input 1	Arose again ¹
Daybdy._I1↑		-	8115		Arose anew

¹ Time arose again because the clock was reset.

Display	Event	Keypad entry	"Interface"	Description	
Data change (e.g. change of counter reading or time)					
Value change↓	Change of archive 1	-	8201	Value for month archive was changed	After change
Value change↑		-	8301		Before change
Value change↓	Change of archive 2	-	8202	Value for measurement period archive was changed	After change
Value change↑		-	8302		Before change
Value change↓	Change of archive 10	-	820A	Value for logbook was changed	After change
Value change↑		-	830A		Before change
Value change↓	Change of archive 13	-	820D	Value for day value archive was changed	After change
Value change↑		-	830D		Before change
Freeze command					
FrMP1	Freeze command archive 2	-	8502	Meas. period archive	Saving the values

3.4 System list

Name	Address	Designation / value	Cal.	Access	Default	DC
Time	1:400	Time and with  to Date	Yes	S	-	2
MdTim	1:407	Summer / winter time on/off	-	S	1	4
MCyc	1:1F0	Measurement cycle	-	S	900 s	3
Disp	2:1A0	Continuous display on/off	-	S	2 min.	4
Aut.V	1:1A0	Time up to automatic display changeover	-	S	1 min.	3
SNo	1:180	DL210 fabrication number	-	P	-	3
Vers	2:190	Software version "Application software"	Yes	-	-	1
Chk	2:191	Checksum, "Application software"	Yes	-	-	1

DC = Data class (for description see Chap. 2.5.1, page 25.)

P/PL/S/C = The displayed value is subject to: "**P**": Calibration lock "**PL**": PTB logbook "**S**": Supplier's lock "**C**": Customer's lock "-": Value cannot be changed.

3.4.1 Description of the values

Time Time

Details of internal clock in 24 format (e.g. 17:06:16). The date (format: DD.MM.YYYY) is displayed by pressing the cursor key . During entry the date and the time are displayed and can be changed.

MdTim Daylight saving mode

"0" to "2" is displayed, corresponding to:

"0" = Daylight saving off

"1" = Daylight saving automatic according to PTB stipulation.

"2" = Daylight saving changeover via adjustable times

In Mode "2" any times can be set which are needed to switch from summer to winter time and back again, because they, for example, deviate from the PTB times. These must then be adjusted annually if required. The following details are then needed:

- Changeover from winter to summer time: **1:4A0**
- Changeover from summer to winter time: **1:4A8**

The details must be given in the format: "yyyy-mm-dd, hh:mm:ss".



With a change of the mode, the time in the DL210 is automatically corrected and should therefore be checked.

MCyc Measurement cycle

Time interval at which all data (e.g. meter readings, measurements, time) are updated. Reaction to events can only take place on this cycle (e.g.: end of measurement period). The display is also only updated on the measurement cycle. The measurement cycle is superimposed right-justified as a unit and numerical value.

- ☞ **The shorter the time is selected, the more often the measurements are updated and the more the battery service life is reduced !**
- ☞ **The measurement cycle can only be set to a multiple or to an integer divisor of 60 seconds (e.g.: 15s, 60s, 120s, 180s; smallest set value: 10s; default: 900s).**
- ☞ **The measurement cycle must also be matched to the measurement periods used; e.g.: with a measurement cycle of 120 s a measurement period of 5 leads to asynchronous saving of data (06:00; 06:06(!); 06:10).**

Disp Continuous display on/off

Time in minutes from the last key depression till the switch-off of the display.

DISP 0 Continuous display on; the display is continuously active
(Important: Increase in current consumption)!

DISP x Continuous display off, the display goes out after x minutes.

The switched-off display is switched on again by pressing a key; the function AUT.V is retained.

Aut.V Time up to automatic display changeover

Time in minutes from the last key depression up to selection of the standard display "V1" (Main Counter in Input 1).

AUT.V 0 No automatic selection.

AUT.V x Display switchover after x minutes.

SNo Device number DL210

The 12-place device number of the DL210 is displayed. The details correspond to the name-plate on the front membrane.

Vers Version of the application software

The version of the application software is displayed.

Chk Checksum of the application software

Test sum of the loaded application software.

3.5 Service list

Name	Address	Designation / value	Cal.	Access	Default	DC
Bat.R	2:404	Remaining battery service life	-	-	-	2
Bat.C	1:1F3	Battery capacity	-	S	13.0 Ah	3
VBatM	4:410	Battery voltage of GSM modem	-	-	-	2
St.SL	3:170	Supplier's lock status / close	-	S	1	4
Cod.S	3:171	Supplier's combination, enter / change	-	S	0	7
St.CL	4:170	Customer's lock status / close	-	C	1	4
Cod.C	4:171	Customer's combination, enter / change	-	C	0	7
St.PL	1:170	Calibration lock status / close	-	P	0	4
Adj.T	1:452	Clock adjustment value	Yes	P	Var.	3
Save	1:131	Manual backup	-	S	-	6
Clr.A	1:8FD	Clear archives	-	P	-	6
Clr.V	2:130	Clear counters (incl. archives and readout notes)	-	P	-	6
Clr.X	1:130	Execute restart	-	P	-	6
Addr	13:1C2	User-specific value	-	S	-	3
Various	Various	Displays the value set under "Add"	Depends on value			
-	1:1F7	Display test	-	-	-	6

DC = Data class (for description see Chap. 2.5.1, page 25.)

P/PL/S/C = The displayed value is subject to: "**P**": Calibration lock "**PL**": PTB logbook "**S**": Supplier's lock "**C**": Customer's lock "-": Value cannot be changed.

3.5.1 Description of the values

Bat.R Remaining battery service life

Display of the remaining battery service life in months. If this is less than three months, the "B" symbol in the display flashes and a status message is generated to indicate an imminent battery replacement.

The calculation of the remaining battery service life occurs in dependence of the consumed capacity (which is measured) and a mean consumption (which gives the remaining battery service life) depending on the operating mode. If a higher additional consumption occurs (e.g. due to frequent reading out), this can result in the remaining battery service life reducing more quickly than the figure quoted for the service life after changing the battery.

Recalculation of the remaining battery service life is carried out automatically after the entry of a new battery capacity (see **BAT.C**).

Bat.C Battery capacity in Ah

Display of the battery capacity in ampere-hours of the installed battery as new (constant). After a battery replacement it is essential to enter the capacity of the battery used so that recalculation of the remaining battery service life is initiated.

Since with operation over the complete ambient temperature range, the battery does not provide the full capacity, about 20 % of the capacity specified by the manufacturer should be subtracted to ensure that the battery is not prematurely discharged. For the standard operating mode of the DL210 (Md.I1=1, MP.I1=60, MCyc=900) this means:



Battery identity number: 73015774 --> Entry in the DL210: 13.0 Ah

Remaining service life (display: "BAT.R"): **150 months**

Battery identity number: 73016294 --> Entry in the DL210: 1.6 Ah

Remaining service life (display: "BAT.R"): **18 months**



VBatM Modem battery voltage in volts

Displays the present battery voltage of the installed modem battery in volts. If the battery voltage drops **below the figure 3.4 V**, the battery must be replaced. To display the present value a refreshed measurement of the voltage can be carried out with ENTER (press the keys  and  simultaneously). In running operation it is automatically updated at the next call window. Consequently, it can also be later found out whether there is enough voltage available at the call window. If it is too low, the GSM modem cannot log into the GSM network.

The service life of the modem battery essentially depends on the duration of the call window; the shorter is the interrogation cycle and the longer the window is open, then the shorter the battery service life (see Chap. 3.6.3).

St.SL Supplier's lock status and close

Depending on the status of the supplier's lock a "0" (= closed) or "1" (= open) appears. Here, it is only possible **to close** the supplier's lock.

To close the supplier's lock, the entry mode is activated with ENTER and the "1" begins to flash. This must be switched over with  or  and terminated with ENTER. Then the display "0" appears and the supplier's lock is closed.

Cod.S Enter supplier's combination and change combination

Here, the supplier's lock can **only be opened or changed**, but not closed. The supplier's combination must be entered with 8 places. The lock is opened after the correctness of the combination has been checked. An incorrect combination produces the error message ----7---.

With the lock opened a new supplier's combination can be entered here.

The procedure for opening, changing and closing the supplier's lock is comprehensively described in Chapter : 2.6.4.

All places not changed are automatically written with "0" due to the default combination **00000000** and the entry procedure. This must also be taken into account when entering the combination via the interface.

St.CL Customer's lock status and lock closed

as above under St.SL, but for the customer's lock.

Cod.C Enter customer's combination and change combination

as above under Cod.S, but for the customer's lock.

St.PL Calibration lock status and lock closed

as above under St.SL, but for the calibration lock.

Adj.T Clock adjustment

Displays the clock correction value. Through the reciprocal the number of seconds can be established for the interval after which the DL210 automatically subtracts or adds 1 second to compensate the inaccuracy of the clock crystal.

It should be noted that the ambient temperature of the device has a very large influence on the clock accuracy. In particular low temperatures lead to the clock running slower and so the measurement period of the device is longer.

Save Manual backup



Here, it is possible for the user to carry out a manual backup of all system data, date, time, counter readings and the determination of the maxima in the current month. This is a backup so that, for example with an ensuing battery replacement, it is ensured that the data is not lost. In addition, the new battery should first be connected before the old one is removed.

Clr.A Clear measurement archives

All measurement archives (not log book and changes log book "audit trail") are cleared, incl. their readout notes. This function is particularly practicable after the measuring point of the DL210 is changed.

In order that the archives are not unintentionally deleted, the following safety mechanism is integrated: To clear the archives the DL210 serial number (found on the name-plate of the device) must be entered.

Clr.V Clear counters, incl. archives

After calling by ENTER, an "0" is positioned right-justified in the display. After selecting "1" with  or  and termination with ENTER, the function is initiated, i.e. all **counter readings**, **archives** (measurement period and month archives) and **readout notes** are cleared. Similarly, all intermediate values associated with volume and flow calculations are deleted.



 **This function may only be executed when there is no link (by remote data transfer or optical interface) to the DL210, because it would be uncontrollably interrupted.**

Clr.X Execute restart

With this function the DL210 can be reset to a defined initial status. The DL210 is completely cleared and "forgets" all settings (comparable to Format c:\ with a PC!) and the values in the archives.

- ☞ **The function should therefore only be executed by trained persons with appropriate operating equipment, because a complete parameterisation with, where applicable, calibration must then be carried out.**
- ☞ **This function may only be executed when there is no link (by remote data transfer or optical interface) to the DL210, because it would be uncontrollably interrupted and not then reset.**

The following steps are necessary to trigger the function:

1. First, the date must be set to the default date. This is needed to prevent the function being triggered unintentionally. To do this, call the time, press "ENTER", reset the date to the start date using "HOME/CLR" and terminate using "ENTER" again.
2. The function "Clr.X" can then be triggered. To do this call the display "Clr.X" again. A "0" is located to the right in the display. With "ENTER" and changing using the key  or  to "1" and by terminating with "ENTER", all counter readings, all archives and the system data (all parameters) are cleared and the DL210 is restarted.
3. After the "busy" signal and checking the internal memory, the DL210 is reset and can be put into operation again.

Addr User-specific value

Here, a user-specific value (address) can be set, the result of which is displayed in the DL210 display using . Consequently, it is possible to bring **any** DL210 value into the display. This is, for example, of relevance during a calibration inspection. The value can of course also be changed in dependence of the locks.

- ☞ **The representation in the display depends on the selected value. For example, during the selection of a status message or an event, the display is formatted according to the Chapter 3.3.13.1, whereas the output occurs via the interface in hexadecimal representation. It is also represented in hexadecimal in the rating data book.**

- Display test

When this point is selected, all LCD segments flash at a frequency of 0.5 Hz until the next key depression.

3.6 Interface list

Name	Address	Designation / value	Cal.	Access	Default	DC
GSM.N	2:775	Network operator in plain text	-	-	-	2
GSM.L	2:777	Reception level	-	-	0	2
StM	2:77C_1	Modem status	-	-	Logged out	2
P.Sta	2:77A	Status PIN of SIM card	-	-	PIN New	2
PIN	2:772	Entry of the PIN for the SIM card	-	S	-	3
Num.T	2:720	Number of ringing tones before accepting call.	-	S	1	3
Bd.S1	1:709	Baud rate for optical interface	-	S	9600 Bd	3
CW1.S	10:150	Call window 1, start	-	S	01, 00:00	3
CW1.E	10:158	Call window 1, end	-	S	01, 00:00	3
CW2.S	11:150	Call window 2, start	-	S	01, 00:00	3
CW2.E	11:158	Call window 2, end	-	S	01, 00:00	3
CW1.S	23:150	Call window 3, start	-	S	00:00	3
CW1.E	23:158	Call window 3, end	-	S	23:59	3
CW2.S	24:150	Call window 4, start	-	S	01, 00:00	3
CW2.E	24:158	Call window 4, end	-	S	01, 00:00	3
CWTst	2:727	"Test" call window	-	S	0	3
RES.1	2:742	Response to last sent Message 1 (to telephone no. 1)	-	-	-	2
RES.2	2:74A	Response to last sent Message 2 (to telephone no. 2)	-	-	-	2
Send	2:734	Command, send message now	-	S	0	4

DC = Data class (for description see Chap. 2.5.1, page 25.)

P/PL/S/C = The displayed value is subject to: **"P"**: Calibration lock **"PL"**: PTB logbook **"S"**: Supplier's lock **"C"**: Customer's lock **"-"**: Value cannot be changed.

3.6.1 Description of the values

GSM.N Display GSM network operator

When using the GSM modem the network operator, in whose network the DL210 has logged in, is displayed in plain text. This display is also a way of ensuring that the DL210 is logged into the GSM network.

The network operator is found at the start of each call window. Immediate updating can be carried out manually by pressing the "ENTER" key combination.

If the modem voltage (battery or ext. supply) is too low, the modem does not log into the network and the message "Low Batt" is written into the display.

Simultaneously the message number 9 (see Chap.3.3.9 and 3.3.10) is set in the momentary status St.4.

GSM.L Display GSM reception level

When using a GSM modem, the reception level is displayed. The display occurs in %:

0 % no reception
100 % best reception

For a reliable data transfer a constant reception level > 50% is recommended!

The reception level is found at the start of each call window. Immediate updating can be carried out manually by pressing the "ENTER" key combination.

StM Modem status

The modem status indicates the current log-in status of the GSM modem.

The possible messages are as follows:

Display messages	Description
Logged out	The GSM modem is currently not logged in. Possible causes: Call window off, no SIM card inserted, SIM PIN not entered.
Own network	The GSM modem is currently logged into its own network.
Network search...	The GSM modem is at the moment logging into its own or a third party network.
Denied	The GSM modem log-in has been denied.
Third party network	The GSM modem is currently logged into a third party network (roaming).

P.Sta Status of PIN on SIM card

When using a GSM modem, the PIN of the SIM card is supported. The possible SIM card messages are as follows:

PIN NEW No PIN interrogation carried out yet.
PIN READY Use of a SIM card without enabled PIN interrogation.
PIN OK PIN is correctly set.
PIN ERROR PIN is incorrect

PIN Entry of PIN for a SIM card

In the DL210 operation of a SIM card using the PIN is supported. This means that the card can be secured against theft or it being used further. Entry takes place concealed (as for example with the entry of the supplier's lock, see Chap. 2.6.4) and is described in Chap. 5.3.3. Only figures from 0 to 9 can be entered.

Num.T Number of ringing tones before accepting call

Setting for the number of ringing tones before the modem accepts an incoming call (can be set between 1 and 12 ringing tones).

Bd.S1 Baud rate for optical head / direct readout cable

Setting for the baud rate of the 1st serial interface. Practical values are located in the range from 1200 to 9600 baud.

CW1.S Call window 1, start	(e.g. 01,07:30)
CW1.E Call window 1, end	(e.g. 01,09:30)
CW2.S Call window 2, start	(e.g. 01,12:00)
CW2.E Call window 2, end	(e.g. 01,13:00)
CW3.S Call window 3, start	(e.g. 00:00)
CW3.E Call window 3, end	(e.g. 23:59)
CW4.S Call window 4, start	(e.g. 01,00:00)
CW4.E Call window 4, end	(e.g. 01,00:00)

Data recalls via the modem are only possible at the times defined by these time windows. In contrast the sending of SMS messages occurs independently of the call windows.

The call windows 1 and 2 are conceived in order to be able to only establish a connection to the DL210 at certain times during *battery operation*. Outside of these windows a connection is only established with an external voltage supply and an appropriately configured time window 3 or 4.

The call windows 1 and 2 should be as short as possible so that the modem battery is not loaded unnecessarily. For more details on calculating the service life see Chapter: 3.6.3.

The call windows 3 and 4 are conceived in order to be able to only establish a connection at certain times during *external voltage supply*. Outside of these windows or when the voltage supply fails, a connection is established in the battery mode with an appropriately configured time window 1 or 2. With an external mains supply it is practicable to configure one of these time windows to "daily, 00:00 hrs – 23:59 hrs"!

Using the WinPADS parameterisation software the time window periods can be set to monthly, weekly or daily.

With the above example values for the call window incoming calls are accepted with an external voltage supply present daily between 00:00 hrs and 23:59 hrs. If the external voltage supply fails, then with a modem battery present a call is only accepted on the 1st of the month between 07:30 hrs and 09:30 hrs, as well as between 12:00 hrs and 13:00 hrs.

CWTst "Test" call window

The "Test" call window enables the GSM modem to be switched on for a parameterised time (e.g. 30 minutes) to make, for example, test calls. The smallest possible entry is two minutes. After initiating the function the display is refreshed every minute and indicates the remaining open time of the call window.

This call window is also opened for two minutes if the GSM parameters in the display are to be updated and in this period no call window (1 – 4, see above) is open.

RES.1 Last response to Message 1

Result of the last message which was sent to Phone Number 1.

RES.2 Last response to Message 2

Result of the last message which was sent to Phone Number 2.

Send Command, send message now

Sending a message can be initiated here for test purposes. A prerequisite for this is the correct parameterisation of the SMS setting of the readout and parameterisation program WinPADS200-DL.

To send the message the entry mode is called with the key "ENTER" and the number of the event from the event list is entered on the base of which the message is to be sent. The DL210 then sends the message. In this way, the function of the settings made can be tested.

Up to ten messages can be saved in a queue if they are to be sent within a short period. All messages in the queue can be deleted by entering "0" for SEND.



The parameterisation necessary for using the SMS functions can only be carried out via the WinPADS program! Description of the parameters which can be set: Chap. 3.6.4

3.6.2 Optical interface (Interface 1)

All DL210 values can be called via the optical interface and also changed in dependence of the locks. This is primarily intended for simple parameterisation of the DL210 via the Elster-Instromet software WinPADS (from V2.70). The connection of an AS-200 (from V8.4) with OPTO head for setting the values and for reading out the archives for transfer to the control room is also possible.

Transmission via the interface occurs according to the IEC 62056-21 protocol (IEC 1107), which is, for example, very popular in the electrical field. The optical head required for reading out is automatically held on the read-out interface by a metal ring and a receptacle. In order to ensure the optimum data flow, the optical head should be positioned such that its connection cable points downwards (in the direction of the cable entries).

Optionally a suitable programming cable (Elster-Instromet identification number: 73017970) can be used to be able to establish a connection within the terminal compartment of the DL210 via the X2 plug when the DL210 is supplied without an optical interface.

3.6.3 Modem operation in the DL210 (Interface 2)

Depending on the version, the DL210 has an integrated GSM or GSM/GPRS modem. All values can be called via this GSM modem and also changed in dependence of the locks. Primarily however, the modem is intended for the transfer of the consumption data (counter readings) in the measurement period archive or the end readings and maxima in the month archive to the control room.

A prerequisite for the operation of a GSM modem is the separate modem battery (option: two pieces) and / or the external voltage supply. When using an external voltage supply the modem battery (if present) is relieved depending on the time window (see Chapter 3.6.1). At the start of the call window and continuously during the transmission a check is made of whether this power supply is provided. If it is not connected, the link is immediately relinquished.

Since the DL210 is as standard designed for GSM operation without an external power supply, the frequency and duration of the call windows 1 and 2 are of decisive importance for the service life of the modem battery. The ambient temperature of the device, the on-site reception conditions (!), the number of transmitted SMS messages and the respective duration of the data transmission also have an effect.



If the DL210 is equipped with a GSM/GPRS modem, an external voltage supply is mandatory when using the GPRS function. The standard GSM functions (establishing a connection, SMS) are also available in the battery mode.

The device battery on the CPU board is exclusively responsible for any calibrated device function (pulse counting, processing and archiving). Therefore, these functions are completely independent of the state of the modem battery or batteries.

3.6.4 Short messages in the DL210 (SMS function)

Short messages (SMs) can be sent to recipients over various networks using the SMS (Short Message Service). In the DL210 an SM can be used to give users information on a defined event. This may be, for example, an internal device message (alarm, warning), the switching of an input (tamper contact), exceeding of limits or also the end readings and the maxima formed in the DL210 at the end of the month.

With the DL210 SMs can be sent to mobile phones or to a control room equipped with a GSM receiver and an SM reception program (e.g.: dmail). Up to five different recipient and up to three different provider telephone numbers can be saved in the device.

3.6.4.1 Basic set-up of the SMS function

The parameters relevant to SMS can only be set via the interfaces. Entry of the SMS parameters via the DL210 keypad is not provided. Entry is made with the WinPADS200-DL readout and parameterising program (possible via the local interface or via remote data transfer).

Number of transmission attempts Address: **2:732**
The number of attempts to send an SM to Recipient 1 and/or Recipient 2 can be set at this address.

 **The DL210 can only establish whether the SM has been properly accepted by the control room. It cannot establish whether it has actually reached the recipient. This should be borne in mind with application in safety-relevant equipment.**

'SMS-to-e-mail' gateway number Address: **2:739**
Telephone number of the 'SMS-to-e-mail' gateway of the device's own provider if it offers this service, e.g. "8000" for T-Mobile and "3400" for Vodafone. The precise requirements must however be taken from the respective provider's specification. Apart from the ten numbers 0...9, the following characters, which must be regarded as being dependent on the relevant modem, may be contained in the phone number for the control of the modem function during the dialling process:

Character	Meaning
0...9	Figures 0...9 for phone number
,	Dialling pause. Ex-works setting for most modems = 2 seconds
Space	Space

'SMS-to-fax' gateway number Address: **2:73A**
Telephone number of the 'SMS-to-fax' gateway of the device's own provider if it offers this service, e.g. "99" for T-Mobile and Vodafone.

For further details refer above: "'SMS-to-e-mail' gateway number"

Type of SM transmissionAddress: **2:740**

Type of transmission for the short message (0=Analogue, 1=Text mode or 2=PDU mode).

0 = Transmission via the provider's analogue access (e.g. analogue, ISDN modem)

1 = Pure text transmission without special characters on a mobile phone / PC

2 = Direct data transfer in binary form on a PC

SMS service centre (own GSM network)Address: **2:743**

If the SMSC recorded on the SIM card is not to be used, an alternative number for the device's own provider can be entered here.

3.6.4.2 Content and form of an SM

An SM sent from the DL210 contains the following user data:

- Header information from SMSC (SMS centre).
- Content which is defined in the DL210.

The **header information** consists of the phone number of the SM sender (DL210) and the time/date of reception of the SM at the SMS centre. The recipient of the SM is shown these automatically.

The content of the respective SM can be chosen from either a list with permanently defined messages (Elster-Instromet) or a list with user-defined messages and be sent to up to two different recipients from the internal telephone book.

a) User-defined messages (free layout)Address: **1:750 to 10:75E**

Up to ten "free" messages can be defined, each consisting of up to 15 variable values (measurements, parameters, etc.). The addresses of the values to be transferred are set to define the message. In this respect it should be noted that a normal message ("Short Message" or "SM") may consist of up to 160 characters.

Values from archives can be sent with "predefined messages" (page 91).

The following table gives an example of parameterisation which describes the message definition "2".

⌵ These addresses must be set.

No.	Address	Value	Meaning	Example
1	2:750	02:0181	Manufacturer's name	Elster-Instromet
2	2:751	01:0181	Device designation	DL210
3	2:752	01:0180	Serial number	3221234
4	2:753	01:0400	Current time	2004-02-15,14:35:05
5	2:754	01:0100	Current status	13;14;16
6	2:755	01:021B	Customer name I1	Müller Baker
7	2:756	01:08D0	User text 1	"Counter readings Input 1"
8	2:757	01:0200	Main Counter I1	000000123.0000 m3
9	2:758	01:0203	Adjustable counter I1	000246577.0000 m3
10	2:759	-	-	
11	2:75A	-	-	
12	2:75B	-	-	
13	2:75C	-	-	
14	2:75D	-	-	
15	2:75E	-	-	

The values (Nos. 1–15) must be assigned in ascending order and gaps between single values are not permitted.

Separator

A separator (factory setting: "***") is provided between each value. Depending on the mobile phone or reception program, this is converted into an appropriate character. Therefore the separator can be set for each recipient (see page 92).

Customised message textAddress: **1:8D0 to 12:8D0**

If longer message texts are to be output, any texts (each of up to 62 characters) can be entered under the addresses given.

These can only be specified via the "WinPADS" parameterisation software and must then be programmed as a value to be transferred (see value 7 in the above table). It should be noted that a "normal" SM only permits up to 160 characters.

b) Predefined messages ("fixed layout")Address: **12:750 to 15:75E**

The message definitions Nos. 12 to 15 are available for special purposes. In particular in this respect and in contrast to the "free messages" also values from archives can be sent. The message definition No. 11 (addresses 11:750 to 11:75E) is intended for future expansion.

1. Load profile (message definition No. 12)Address: **12:750**

To obtain the load profile of the last day ("load profile from yesterday") the address of a counter is entered under the address 12:750. The load profile is then determined from the values for this counter entered in the measurement period archive.

The following conditions for this must be fulfilled:

- The measurement period "MP.11" must be set continuously to 60 minutes.
- The counter entered here must be present in the measurement period archive.

In the DL210 as supplied the readings of the main counter "V1" and of the adjustable counter "V1.A" are recorded in the measurement period archive "ArMP1" according to Chapter 3.2.3 (page 47). The addresses of these counters are "1:0200" for "V1" and "1:0203" for "V1.A" (see Chapter 3.1, page 35). One of these two addresses can in this case be entered under 12:750.

If, for example, "1:0200" is entered under 12:750, the DL210 sends the load profile of the main counter "V1" when an event occurs for which the message definition "12" has been set (see page 93).

Using the "WinPADS" parameterisation software, you can set which counters are recorded in the measurement period archive, e.g. for the connection of an encoder to the counter input of the original counter "Vo" (address 1:0240, see page 35). In this case the address "1:0240" can be entered under 12:750 to transmit the counter reading profile of the original counter.

2. Alarm message (message definition No. 13)Address: **13:750 to 13:759**

Up to 10 addresses can be specified under the addresses 13:750 to 13:759, the values of which are to be transmitted when an alarm message occurs.

3. Last archive entry (message definition No. 14)Address: **14:750**

To transmit the last (newest) data row of an archive by SMS the address of the block number of the respective archive is entered under the address 14:750. The address is formed from the archive number followed by ":0A20". (Archive numbers: see the table on page 53).

Example: To transmit the last archive entry in the measurement period archive the address "2:0A20" is entered under 14:750.

4. Monthly billing (message definition No. 15)Address: **15:750 to 15:754**

With this definition the relevant data for a monthly invoice can be transmitted. This is the counter end reading and two so-called "capture values" (maximum or minimum with time stamp) of the previous month.

It is essential to parameterise the following parameters exactly in this sequence, so that the Elster-Instromet evaluation software can interpret the data correctly.

└ Possible (practicable) entries

Address	Meaning	Entry	Meaning
15:750	Counter reading	1:0200	Main counter
		1:0203	Adjustable counter
		1:0240	Original counter (with connected encoder)
15:751	First capture value	3:0161	Max. measurement period consumption
		4:0161	Max. day consumption
15:752	Time stamp for first capture value	3:0165	Time of max. meas. period consumption
		4:0165	Time of max. day consumption
15:753	Second capture value		(as "First capture value")
15:754	Relevant time stamp		(As "Time stamp for first capture value")

3.6.4.3 SM provider list

Provider's name Address: **1:D10 to 3:D10**
 Provider's name in plain text for the user guidance during configuration.

Dial-up number of network provider Address: **1:D11 to 3:D11**
 Dial-up number for the SMSC (SMS centre) for sending messages. If no dial-up number is entered (default!), the dial-up number on the SIM card set by the provider is used.

3.6.4.4 SM recipient list

Up to five different recipients can be saved in the device.

Name of the recipient Address: **1:D20 to 5:D20**
 Recipient's name in plain text for the user guidance during configuration.

Telephone number Address: **1:D22 to 5:D22**
 Recipient's telephone number.
 Apart from the ten numbers 0...9, the following characters, which must be regarded as being dependent on the relevant modem, may be contained in the phone number for the control of the modem function during the dialling process:

Character	Meaning
0...9	Figures 0...9 for phone number
,	Dialling pause. Ex-works setting for most modems = 2 seconds
Space	Space

E-mail address Address: **1:D23 to 5:D23**
 Recipient's e-mail address in the format: name@host.xxx.

Message format Address: **1:D24 to 5:D24**
 Definition of whether the message is to be sent as text or in binary representation (0 = text,

1 = binary). With the "binary" format the SM is sent compressed for a PC recipient. This recipient must then decompress the SM.

SM separator

Address: **1:D25 to 5:D25**

Character for delimiting a text message into its single fields. It should be noted that this must be entered in "decimal" (extract from the ASCII table):

Decimal	Character	Decimal	Character	Decimal	Character	Decimal	Character
09	TAB	35	#	46	.	61	=
32	Blank	42	*	58	:	64	@
33	!	45	-	59	;	124	

3.6.4.5 SM event list

Up to ten different trigger events can be saved in the device on the occurrence of which a short message (SM) is sent. For each single event the recipient, the message to be sent and the transmission path are defined.

Event for triggering an SM

Address: **1:D00-10:D00**

To send an SM, the event must be defined due to which the SM is to be sent. Description of the events: See Chap. 3.3.13.

SMS mode

Address: **1:D01-10:D01**

In the DL210 it is possible to send an SM to up to two different recipients. This is set in the "SMS mode":

Value	Meaning
0	No SM transmission
1	SM to Recipient 1; if unsuccessful, also to Recipient 2.
2	SMS to Recipient 1 and Recipient 2.

Message definition (layout)

Address: **1:D02-10:D02**

Here the number of the message definition is entered according to which the message is to be sent on the occurrence of the above mentioned event.

This is either a number from 1 to 10 for "User-defined messages" (page 90) or a number from 11 to 15 for "Pre-defined messages" (page 91).

SM Recipient 1

Address: **1:D04-10:D04**

SM Recipient 2

Address: **1:D05-10:D05**

Number of the entry in the SM recipient list. This defines Recipients 1 and 2 to whom an SM is to be sent.

Transmission path to SM Recipient 1

Address: **1:D06-10:D06**

Transmission path to SM Recipient 2

Address: **1:D07-10:D07**

Definition of the transmission path of the message to the respective recipient:

0 = Direct The recipient receives the message on the same path on which it was sent (via SMS).

1 = E-mail The recipient receives the message as e-mail. Assumptions:
- the recipient's e-mail address is entered under the address 01...05:D23 (see page 92).
- the telephone number of the "SMS-to-e-mail" gateway is entered under the address 02:0739. (see page 88).

2 = FAX The recipient receives the message as a fax. Assumption:
- the telephone number of the "SMS-to-fax" gateway is entered under the address 02:073A. (see page 88)

Delay range

Address: **1:D0A-10:D0A**

In order to relieve the recipient of regular short messages within an interconnection of devices, it is possible in the DL210 to delay the sending of an SM depending on the device. The delay range corresponds in this respect to the maximum desired delay in minutes. If, for example, a delay range of 60 minutes is set, the message is sent some time within 60 minutes of the occurrence of the triggering event. The values sent in the message are however values valid at the time of the triggering event.

3.7 User list

Name	Address	Designation / value	Cal.	Access	Default	DC
V1.A	1:203	Adjustable counter I1	No	S	0	3
V1	1:200	Main Counter I1	Yes	PL	0	3
V1M.L max	3:0161	Max. meas. period consumption in last month	Yes	P	0	1
Date	3:0165_1	Date of the maximum of the meas. period counter I1 in the last month	Yes	P	-	1
Time	3:0165_2	Time of the maximum of the meas. period counter I1 in the last month	Yes	P	-	1
V1D.L max	4:0161	Max. day counter I1, last month	Yes	P	0	1
Date	4:0165_1	Date of the maximum of the day counter I1 in the last month	Yes	P	-	1
Time	4:0165_2	Time of the maximum of the day counter I1 in the last month	Yes	P	-	1
S.Reg	1:101	Status register	No	-	0	1
StM	2:77C_1	Modem status	-	-	Logged out	2
Bat.R	2:404	Remaining battery service life	-	-	-	2
Time	1:400	Time and with  to date	Yes	S	-	2
Menu	1:1A1	Selection for display menu	-	S	1	7

DC = Data class (for description see Chap. 2.5.1, page 25.)

P/PL/S/C = The displayed value is subject to: "**P**": Calibration lock "**PL**": PTB logbook "**S**": Supplier's lock "**C**": Customer's lock "-": Value cannot be changed..

With exception of the last value, this list is application-specific, i.e. the user can himself set which values in this list are displayed. Ex-works, these are the above-mentioned values (default) which are also all displayed in another list and described in the corresponding chapters.

The setting of the values to be displayed occurs by entering the addresses of the values to be displayed with the parameterisation software "WinPADS" - "Configuration", "Display" under the addresses "1:1C2" to "12:1C2".

With *Menu* the complete display structure of the DL210 can be switched between "complete" and "simple".

<i>Menu</i> =	Meaning
1	Complete display structure
2	Only " <i>User</i> " column

Menu = 1 corresponds to the standard setting which is described in this manual.

With the setting *Menu* = 2, the display is limited to the column "User" described here. All other columns cannot be called.

Table for documenting one's own user list entries:

Name	Address	Designation / value	Cal.	Access	Default	DC
Menu	1:1A1	Selection for display menu	-	S	1	7

4 Operation under calibration

4.1 Setting the parameters on site

For Input 1 the mode (counting, signalling or encoding input), c_P value, measurement period, day boundary and, where applicable, the reading of the main and adjustable counters must be set.

☞ **Values identified in the lists with access right "P" can only be changed after the calibration lock has been opened by pressing the calibration button in the device (symbol "P" flashes in the display). Values identified with "PL" can be changed with the supplier's lock open provided the PTB logbook is not full. (See Chap. 3.3.1, page 57).**

4.2 Checking the set values

Checking the set parameters can take place directly on the unit by means of the keypad, (see Chap. 2.4) or conveniently via the WinPADS parameterisation software. The software can be obtained free of charge as a download via www.elster-instromet.com in the section "Download", "Software Download"; the product code can be requested via the Electronics hot-line (Tel.: 06134 / 605-123 or at support@elster-instromet.com).

In the rating data book the associated parameters are clearly described by quoting the address. Values not directly available in the DL210 display can be called in the Service list under the "User-specific value" (see Chap. 3.5).

The correctness of the set parameters is ensured by comparison of the details in the rating data book with the called values in the operator list, (see Chapter 3) or with the WinPADS parameterisation software.

4.3 Calibration inspection

If a calibration inspection is necessary, it is carried out based on the **PTB Regulations Volume 22** according to the example in Chapter 4.2.2.3 for the pulse acquisition and according to Chapter 4.2.1.2 for the acquisition of the maximum.

Further notes and information on the calibration inspection (e.g. testing the accuracy of the clock) can be found in the documentation deposited with the calibration authorities (Appendix to Approvals Certificate, Chap. 2.6, No. 2, Chapter 17).

4.4 Sealing

1. Closing and securing the calibration lock

Once all values subject to calibration have been changed, the calibration lock is closed by pressing the button or by operation on the DL210 ("St.PL" in the "Service" list) (*the symbol "P" goes out*) and the opening is sealed with an adhesive label.

2. Securing the inputs

When used in applications subject to calibration for billing purposes, the required inputs must be secured against tampering by calibration covering caps. Sealing is provided by an adhesive label on the relevant covering cap.

(for seal layout see Chapter □).

☞ *The connection of the measurement device and additional equipment should be sealed by the official, but the **PTB regulations Vol. 22 5.2 Section 5.2.3 Page 29** says: "if such a person is present, this occurs with an official stamp, otherwise securing by the user is sufficient!"*

This must though be previously agreed with the relevant officials.

3. Close the housing

Completely close the housing, secure it with four screws and fit covering strips for the mounting holes.

☞ ***Make sure that no cables are pinched.***

☞ ***Ensure that the screws are securely tightened so that no moisture can penetrate the DL210.***

4.5 Seal layout

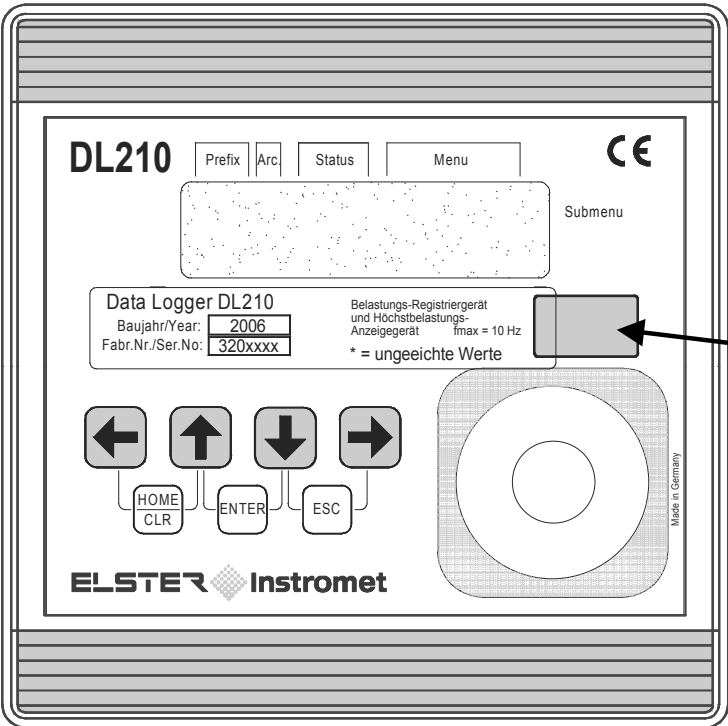

Main stamp

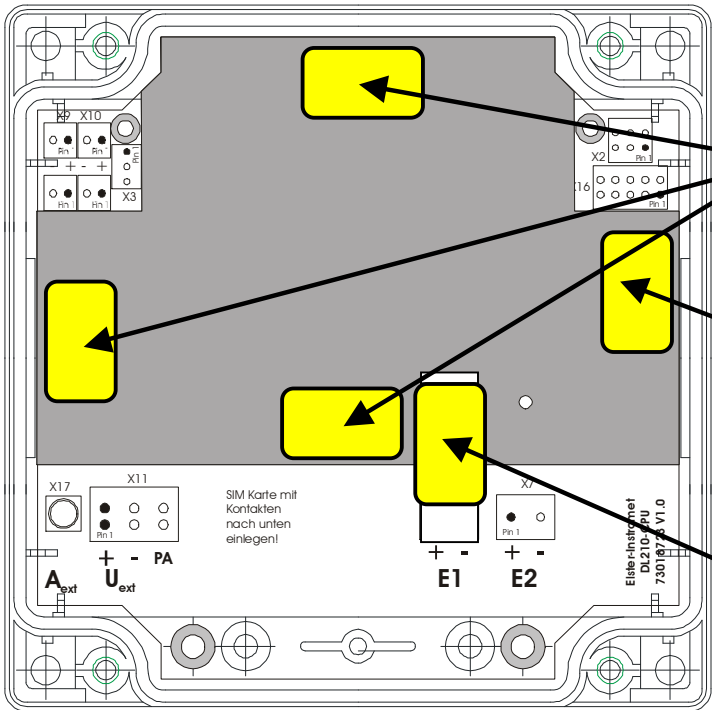

Adhesive seal for mounting screw of circuit board cover

Adhesive seal for mounting screw of circuit board cover and calibration switch

Adhesive seal for input terminals (calibration or user adhesive labels - see Chap. 4.4); here shown for Input 1.

4.6 Recalibration of the DL210

When using the DL210 in applications subject to official calibration, the recalibration periods should be observed.

According to the **Calibration directive – General regulations**, issued in 2000, these recalibration periods are given in Appendix B (Special validity periods for calibration) under the following item number:

7.11 Additional equipment for gas measurement devices with the exception of the transmitter devices and the switching equipment.

In the **Inspection Regulations, Volume 22 from the standards authority (PTB)** the procedures for inspecting electronic supplementary equipment for the formation of new measurements for gas, water and heat are described.

In the last paragraph of Chapter 4.2 (Inspection of measurement system) in Volume 22 a full inspection is only necessary if official stamp labels have been violated.

Otherwise the following is adequate:

- determination of the **correctness of the internal time measurement** based on Chap. 4.2.2 (Devices with internal crystal-controlled clocks) or Chapter 4.2.2.1 (Inspection of the time base).
- inspecting the **control functions** according to 4.2.1 4 (Remark: However, this is not relevant here, because in Chapter 4.2.1 tests for devices **without** internal crystal-controlled time bases are described).

Part 2

Description of the Initial operation

5 Installation

The DL210 is normally intended for mounting on a wall.

After removal of the two covering strips and opening the housing cover, the holes for wall mounting become accessible

The drilling dimensions can be taken from the adjacent illustration.

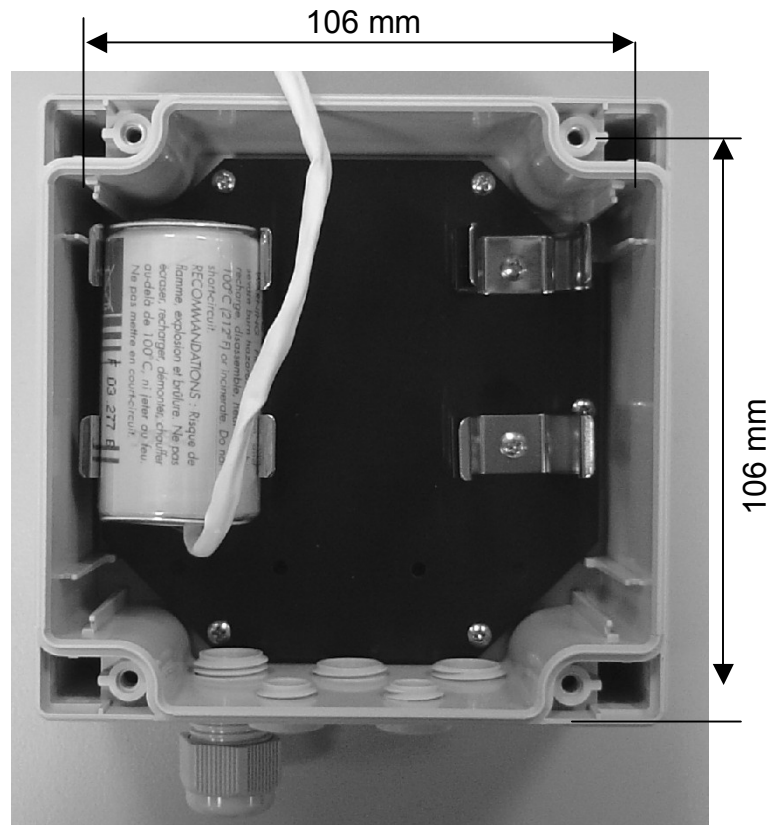

The installation and testing can occur without the presence of a calibration official, because all relevant areas are secured by adhesive labels.

However, when used as a tariff unit subject to calibration, checking of the programmed values and usually acceptance of the measurement point by a calibration official are required.

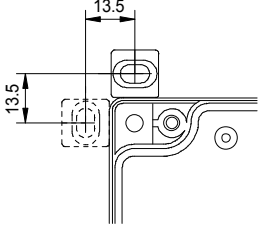
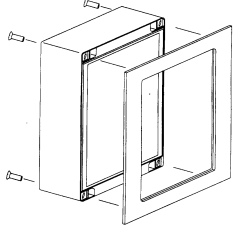
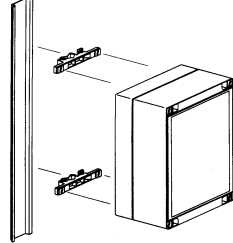

5.1 Mounting options

In addition, the following options can be obtained for mounting the DL210:

Designation	Order number	Drawing
Wall-mounting bracket	04195035	
Control panel mounting frame	04195064	
Top-hat rail holder	04195063	
Pipe mounting (universal retaining angle with suitable pipe clamp)	73018057	

Example of pipe mounting



5.2 Antenna options

5.2.1 Option: External antenna

An external antenna must be used to be able to use the integrated GSM modem:

- GSM antenna, external 4m
(Order no.: 730 18 956)
- GSM antenna, external 10m
(Order no.: 730 18 957)



5.2.2 Option: Housing for GSM antenna

A separate housing for the GSM antenna can be used for concealed mounting (to provide protection against vandalism). Then it is also well-protected against environmental conditions and can be used directly outdoors.

- GSM antenna housing
for external GSM antenna
(Order no.: 730 17 320)

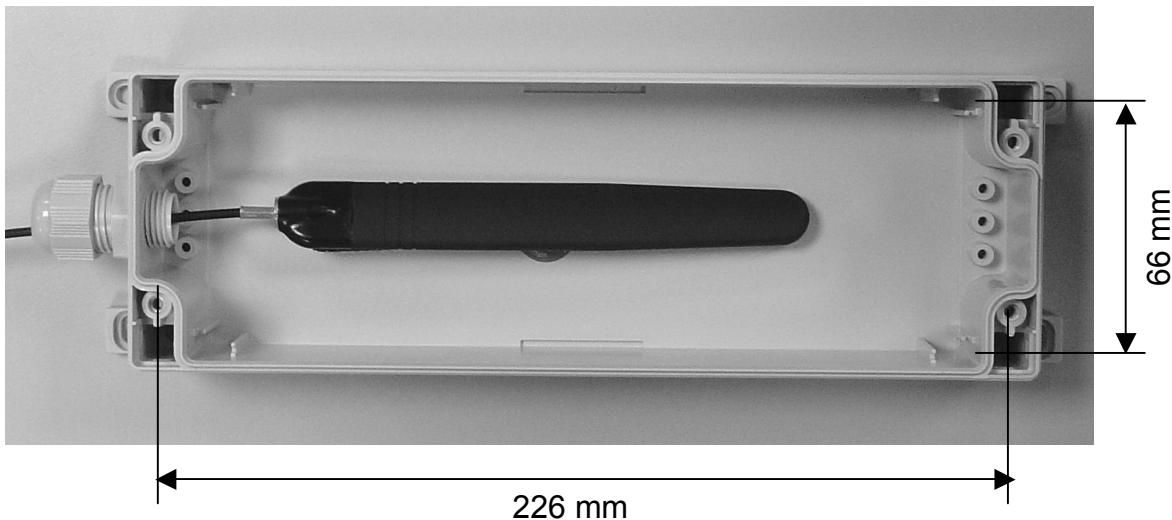

5.3 Installation procedure

 ***The installation and any modification must only be carried out by appropriately trained personnel. Therefore, it is essential that you follow the safety instructions in the preface.***

5.3.1 Mounting the device

- 1. Fitting the cable glands**
Where applicable, fit all additional cable glands in the bottom part.
- 2. Mounting the base section**
Mounting of the base section on the wall, where necessary with the external mounting feet (the cover with the electronics can be first placed to one side). Use corrosion-protected screws so that device can be later removed if necessary.
- 3. Cable routing for inputs**
Bring in the cables for the inputs into the housing via one of the lower cable glands (**length in DL210 approx. 15 cm**).
- 4. Cable routing for external voltage supply**
The cable of the plug-in power supply is brought in via the upper left cable gland (**cable length in the DL210: approx. 15 cm**).
- 5. Antenna for GSM modem**
The DL210 is supplied as standard with an integral GSM antenna. If connection of an external GSM antenna is required, the antenna cable is passed into the housing via the upper right cable glands. When fitting, it must be ensured that the thicker part of the antenna cable is located in the gland so that the housing can be sealed.
- 6. Mounting the GSM antenna housing**
With the use of the external antenna housing it should first only be fixed temporarily so that the best location can be found during initial operation.
The final fixing is realised using 4 holes in the wall (dimensions: see Chap. 5.2).
- 7. Fitting the internal hinges (mounting aid)**
The supplied internal hinges can be fitted as a mounting aid. They are firmly clamped with two screws between the base section and the cover. They only act as a "mounting aid" and cannot be stressed mechanically.

8. Fitting the SIM card

Insert the SIM card, enabled for data transmission, into the SIM card holder. A card with PIN interrogation can be used.

☞ **The card must be pushed in with contacts upwards. Do not touch the contacts with the fingers.**

☞ **Before fitting the SIM card it must be ensured that no modem battery is connected to X12 and X13 and the external voltage supply is switched off!**

Open SIM card holder



Take out SIM card holder after pressing the unlocking button

Insert the SIM card

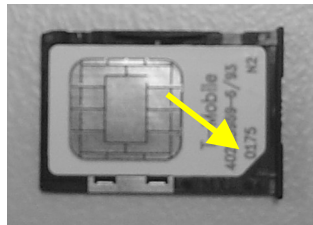

Insert the SIM card into the holder as in the photograph. The chamfered corner of the SIM card must correspond to the chamfered corner of the holder.

Close SIM card holder

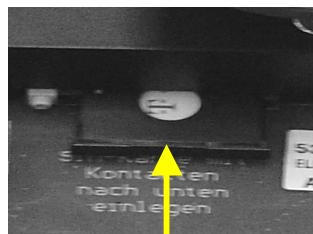

Place the holder with the SIM card in the guide and push up to the end stop. The contacts of the inserted SIM card must here point downwards.

9. Connect all cables to the circuit board

Fit the input and supply cables to the terminals with the aid of core-end sleeves (see Chap. 5.3.2).

☞ **When connecting, ensure the correct polarity; this is printed on the board.**

10. Connecting the modem batteries

The modem battery is connected to X12 after inserting the SIM card. If a second modem battery is used, it should be connected to X13. When using two batteries, it is essential to ensure the same type and batch (adhesive label: BMT week / year) and to only change both batteries simultaneously.

11. Checking components

- Check whether all connections have been made correctly and the connecting cables are relieved of strain.
- Is the SIM card inserted correctly?
- When using an external antenna: Is the antenna plug firmly seated on the connection?
- Are the batteries connected correctly?

12. Fix the cover to the base section with two mounting screws.

 ***Make sure that no cables are crushed when fitting the cover.***

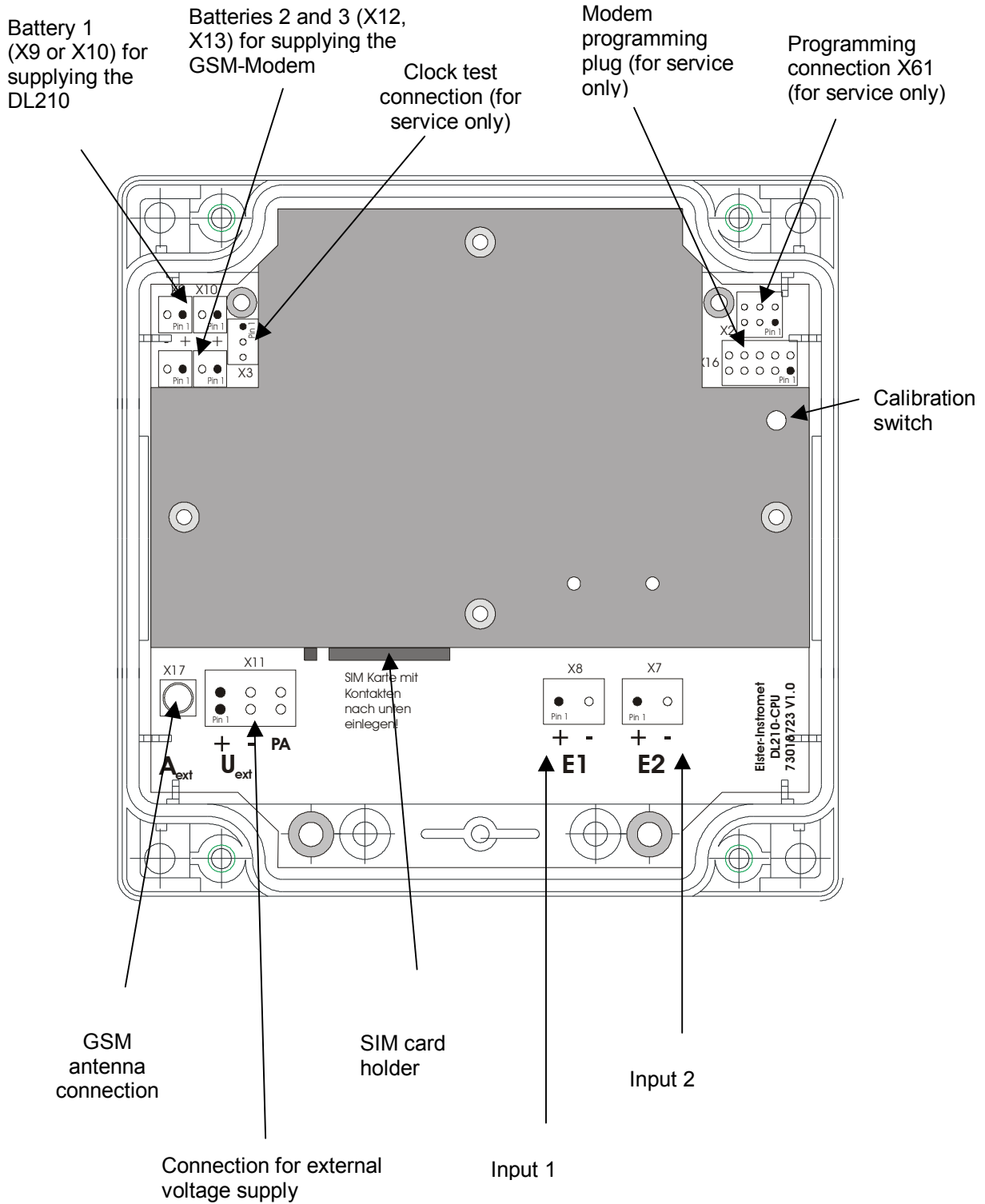

 ***Ensure that the screws are securely tightened so that no moisture can penetrate the DL210.***

5.3.2 Terminal layout



5.3.3 Settings for modem operation

1. Programming the SIM PIN

Programming the PIN for release of the SIM card occurs in the interface list, similar to entering the supplier's combination (see Chapter 2.6.2). After branching to the entry mode by pressing "Enter", the first figure of the PIN is entered by pressing  or  (left-justified entry). Then, change for the entry of the next figure using . In this way combinations of numbers with up to eight places can be entered. If the PIN to be entered is shorter (normally, 4-figure), the entry mode is quit with "Enter" after setting the last place.

2. Time window settings

At the factory the Call windows 1 and 2 (for the battery mode) are switched off so as not to load the modem battery unnecessarily. When putting the device into operation, the required window must be set via the WinPADS parameterisation software.

In order to ensure a long battery service life, the GSM modem is only ready for communication within the parameterised time window. Four independent time windows are available. Time windows 1 and 2 are only valid during the battery mode and Time windows 3 and 4 are only active with an external supply voltage. The setting using the keypad is described in Chapter 3.6.1. It is more convenient however to carry it out using WinPADS for the DL Series. Generally the Time windows 1 and 2 for communication should be kept as short as possible, because the modem battery service life is very significantly affected by the frequency and duration of the set time windows (see Chapter 1.1.1).

☞ Adjustment of the time window period to daily, weekly or monthly can only be implemented using the WinPADS200-DL program. The default setting is monthly.

3. Setting the parameters for SMS (messages)

The DL210 offers the possibility of programming various events which result in the sending of an SMS irrespective of the set time windows (see Chapter 3.6.4). Also in this case, the more often such a message is sent, the shorter is the service life of the modem battery. In the battery mode this function should therefore be primarily used for alarm messages.

5.3.4 Setting the customer-specific parameters

1. Putting into operation

All parameters can be set conveniently via the WinPADS software. The most important values can however also be adjusted via the keypad. The only significant exception are the definitions for sending the short messages, because these are quite complicated. This is carried out exclusively via the WinPADS software.

☞ Values subject to calibration regulations cannot be changed without appropriate authorisation. This can only take place with the calibration lock open (see below).

☞ When using the Elster-Instromet WinVIEW evaluation software, it is essential to set certain values. Refer to Chapter: 5.3.6 !

5.3.5 Functional testing

1. Function tests

The LCD is switched on by key depression and the inputs can be tested (see Chapter).

2. Setting the time

Set the time in the device using WinPADS200-DL or the keypad.

3. Testing counting

With a connected meter with a pulse output the pulse transfer from the meter to the DL210 must be tested for proper function. If an encoder counter is connected, the correct transfer of the encoder counter reading must be checked.

4. Checking the GSM reception / network operator

Under "Interface" – "GSM.N" press the key combination "ENTER". Once logging in is complete, the name of the network operator is displayed.

5. Checking the connection set-up

Open the test call window by entering a value (e.g. 10 minutes) (see Chapter 2). Establish a connection using WinPADS with a connected modem.

☞ ***Make sure that the display of the remaining running period is not "0" during the attempt to establish a connection.***

5.3.6 Setting for interfacing to WinVIEW & WinLIS evaluation software

Some settings must be made for the correct interface to the Elster-Instromet evaluation software, WinVIEW. They can be set via the keypad on the DL210, using the AS-200 or via the WinPADS software:

Address	LIS-200 designation	LIS-100 (DS-100) designation	Remarks	Setting by			Rights ¹
				Keypad	AS-200	WinPADS	
1:21A	Customer number	Customer number	Needed for WinVIEW.	CuNo	Yes	Yes	S
1:22E	DS-100 designation (Counter "V1")	Device no.	Separation of counters in the measurement period archive into 2 DS-100 channels. For recognition, the device number of the DL210 is used where the 6 th position from the right indicates the channel (ex-works setting):	DS.Ca	No	Yes	S
1:22F	DS-100 designation ("V1.A")	Device no.	x1xxxxx = I1 – V1 x2xxxxx = I1 – V1.A	DS.Cb			
13:CF2	DS-100 designation (Counter "V1")	Device no.	Separation of counters in the day value archive into 2 DS-100 channels.	No	No	Yes	S
13:CF3	DS-100 designation ("V1.A")	Device no.	x5xxxxx = I1 – V1 x6xxxxx = I1 – V1.A	No			
1:222	Meter no.	Meter no.	Needed for WinVIEW.	SNM	Yes	Yes	S
1:21C	Meas. point no	-	Not used in the WinVIEW	No	Yes	Yes	S
1:203	Adjustable counter	Adjustable counter	Corresponds, for example to mech. reading of the meter.	V1.A	Yes	Yes	S
5:150	Meas. period	Interval period	When interfacing to WinVIEW, the values are restricted to 5, 10, 15, 20, 30, 60 minutes or the day value of 1440 minutes.	MP.I1	No	Yes	P
1:253	cp value	cp / cpz value	When interfacing to WinVIEW, only the following decade values are possible: 0.01; 0.1; 1; 10; 100.	CP.I1	Yes	Yes	P
5:141	Day boundary	Day boundary	Set ex-works to 06:00 hours.	DB.I1	No	Yes	P
1:208	Unit	-	Set ex-works to "m3".	No	No	Yes	S
-	-	I/O mark	Formed by the readout notices in the DL210 (separate for supplier and customer) and adjustable by readout modes in AS-200 and WinPADS.	No	Yes	Yes	U

¹ Value is subject to: P = calibration lock; S = supplier's lock; U = supplier's or customer's lock

5.4 Maintenance

Apart from battery replacement the DL210 operates largely without needing maintenance. Notice should be taken, where applicable, of the recalibration periods if the DL210 is used in applications subject to official calibration.

When cleaning the housing becomes necessary, no aggressive cleanser (e.g. acetone, petroleum spirit, etc.) should be used, because this may attack the housing. A damp cloth with a soapy solution or similar is quite sufficient.

5.4.1 Battery replacement (basic unit)

During operation a check must be made from time to time of whether the battery needs to be replaced. A display of the remaining battery service life is provided for this in the DL210 under the list "Service".

- ☞ *With the specified standard operating mode (see Chapter: B-2), operation is still possible until as shown in the display. The remaining battery service life, of course, reduces more quickly through more frequent measurement, reading out of the values and active display.*
- ☞ *Battery replacement can be carried out without the presence of a calibration official, because the housing itself is not sealed.*
- ☞ *Measurements (e.g. all load profiles) may be lost due to careless procedures. All set parameters as well as, once daily, the date, time and meter readings are additionally backed-up in an EEPROM, so that these values are not completely lost even after a power failure.*
- ☞ *Generally, replacement should only be carried out by the Service Department of Elster-Instromet or by specially trained personnel.*

5.4.1.1 Carrying out battery replacement

- ☞ *So that no data is lost, a manual backup must be carried out under "Service" – "Save" (Save, address: 1:131). The date, time and all counter readings are then saved in a non-volatile memory.*
- (1) Open up the front cover with the electronics and swivel downwards. The battery is now accessible on the CPU board.
 - (2) Check whether the size and identification number of the new battery match those on calibration cover plate for the fitted device battery. Normally, the device battery has a black connecting cable.

- (3) If one or two modem batteries are present (here a white connecting cable is used) and if they have to be replaced, then this must be carried out first (see Chapter 5.3.1– Point 10).

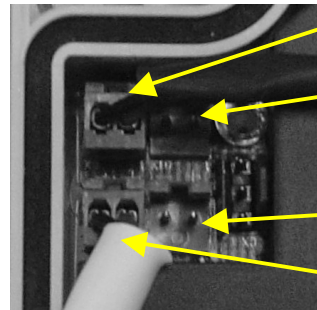

- X9 (Device battery)
X10 (Device battery)
X13 (Modem battery)
X12 (Modem battery)

- (4) Connect the new device battery to the free connector X9 or X10. The connectors are fitted with polarity reversal protection and a mech. interlock.
- (5) Now the old device battery can be pulled off terminal X9 (X10).
- (6) Reclose the device (make sure that the cable is not pinched).
- (7) Check in the display that no message "3" is entered under "Status"!
- (8) The capacity of the new device battery minus about 20% must be re-entered under "Service - "Battery capacity" (BAT.C, address: 1:1F3) (**it is essential to refer to Chapter 3.5.1 – Point "BAT.C**). The entry is also essential even with the same capacity value, so that the computation of the remaining battery service life is re-initiated.
- (9) This successfully concludes the battery replacement.

5.4.1.2 Voltage failure during battery replacement

- ☞ *An operating error during battery replacement (e.g. very brief disconnection of the battery) may result in the short designations in the DL210 display not being correctly displayed.*
- ☞ *In this case the battery must be disconnected again for at least 30 s so that reliable initialisation of the DL210 can take place. After starting, the DL210 should start with "Init Device" and "Reset Database".*
- ☞ *After the start the DL210 signals a voltage failure (Error code "3") and the following values must be re-entered:*
- **Supplier's lock** is closed; for opening see Chapter: 2.6.4).
 - **Time** (in the DL210 the time for automatic saving at 00:00 hrs. or for manual saving was restored- see Chap.: 3.4.1)
 - **Acknowledgement of the error message in the status register** (see Chap. 3.3.12).
 - **The pulses arising from the time of the last backup (00:00 hrs. or the time of the manual backup) up to the insertion of the new battery could not be acquired. The previously backed up counter readings are restored and therefore do not, for example, correspond to the mech. counting mechanism. It must, if applicable, be matched under the calibration lock.**

- ☞ *The determination of the day maxima is only restarted after a correct day termination (normally at 06:00 hrs.). Therefore where applicable, a day maximum arising on the day of the voltage failure is not taken into account. However, the day maximum of the current month found before the day of the voltage failure is correctly restored from the EEPROM.*

5.4.2 Battery replacement (modem battery)

During operation a check must be made from time to time of whether the modem battery needs to be replaced. A display of the modem battery voltage (VbatM) is provided for this in the DL210 under the list "Service". If this voltage is below 3.4V, the modem battery must be replaced.

5.4.2.1 Carrying out battery replacement

1. Open up the front cover with the electronics and swivel downwards. The batteries are then accessible in the bottom of the housing.
2. Check whether the size and identification number of the new battery match the modem battery mounted in the bottom of the housing. Normally, the modem battery has a white connecting cable.

☞ **When using two modem batteries it is essential to note that:**

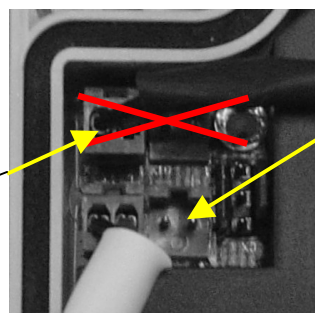

- **Both modem batteries must always be replaced together. Also the retrospective replacement of a second battery is not permissible.**
- **Both modem batteries must always be of the same type and from the same batch (battery label: BMT week / year).**

3. Pull off the existing modem battery or batteries from the terminals X12 and X13 and plug on the new battery or batteries to these terminals. The connectors are fitted with polarity reversal protection and a mech. interlock.



Connection for the modem battery/ batteries

Important: Do not remove the device battery.

4. Reclose the device (make sure that the cable is not pinched).
5. Check in the display that no message "3" is entered under "Status"!
6. Under "Interface" – "Network provider" (GSM.N, address: 2:775) press the key combination "Enter" (press the keys  and  simultaneously). About 30 seconds later the network provided should be displayed.
7. The voltage figure 3.6V should now be displayed under "Service" – "Modem battery voltage" (VBatM, address: 4:410).
8. This successfully concludes the battery replacement.

5.4.3 Battery service life

☞ The device battery is independent of the modem operation so that reliable operation of the DL210 is ensured even with the modem batteries discharged.

The following should help the user to estimate the service life of the batteries.

Since influencing factors, such as readout duration, ambient temperature or quality of the GSM network, during operation are subject to variations, the values of battery service life given here should be taken as guide values and cannot be guaranteed.

Poor reception in the GSM network reduces the battery service life, because the modem then automatically increases its transmission level and therefore requires more current.

In particular with the frequent sending of short messages (SMS function) the figures are subject to a high uncertainty, because the frequency and duration of the required log-in procedures is subject to GSM network variations.

The figures assume that for the DL210 (basic unit) the standard battery (order no. 730 15 774) is used.

a) Monthly readout

Readout duration 30 minutes per month, additionally 1 SMS per month

Readout time window (hours per month)	1	2	3	4	5	6	8	12	24
DL210	12.5	12.5	12.5	12.5	12.4	12.3	12.3	12.3	12.2
Modem (1 battery)	9.3	9.0	8.9	8.7	8.5	8.3	8.0	7.4	6.1

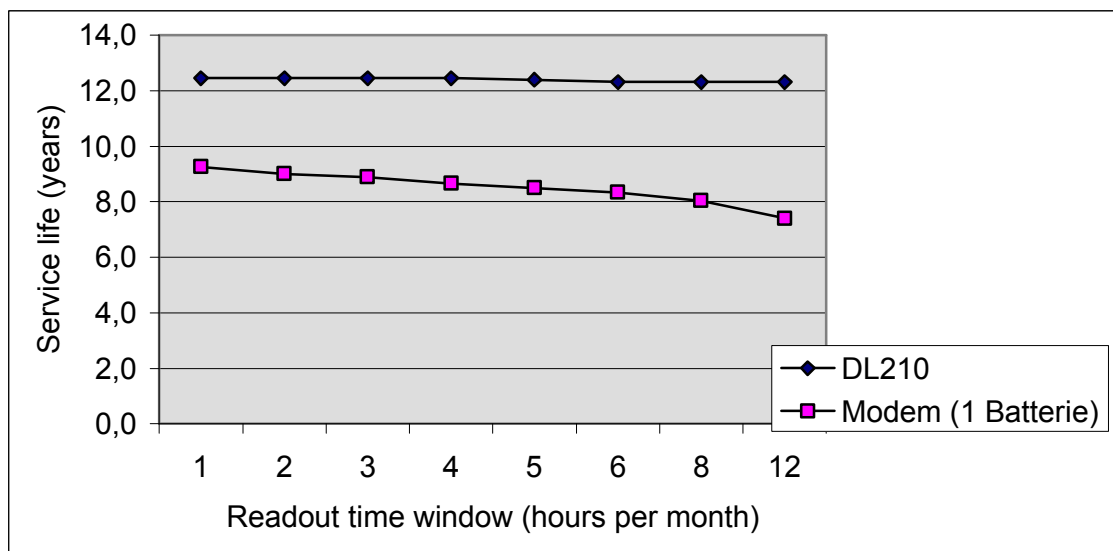

b) Weekly readout

Readout duration 15 minutes per week, additionally 1 SMS per month

Readout time window (hours per week)	1	2	3	4	5	6	8	12	24
DL210	11.8	11.8	11.8	11.6	11.6	11.6	11.5	11.4	11.2
Modem (1 battery)	5.2	4.9	4.7	4.5	4.2	4.1	3.7	3.2	2.3
Modem (2 batteries)	10.4	9.9	9.4	8.9	8.5	8.1	7.5	6.4	4.6

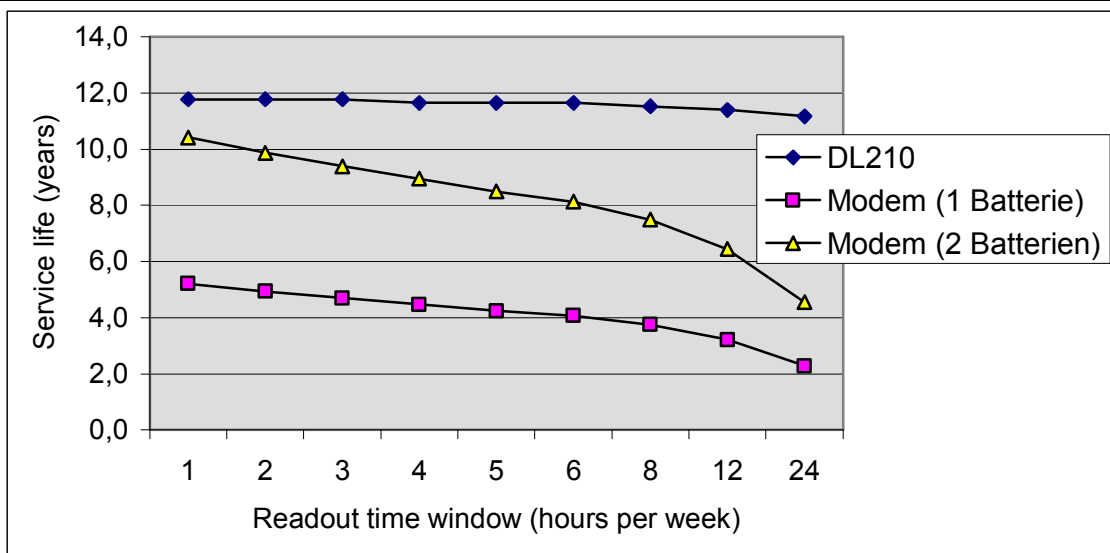

c) Daily readout

Readout duration 5 minutes per day, additionally 1 SMS per month

Readout time window (hours per day)	1/4	1/2	1	2	3	4	6	8	12
DL210	10.1	10.1	10.1	10.1	10.0	9.8	9.6	9.3	8.8
Modem (2 batteries)	4.6	4.4	4.1	3.5	3.1	2.8	2.3	2.0	1.5

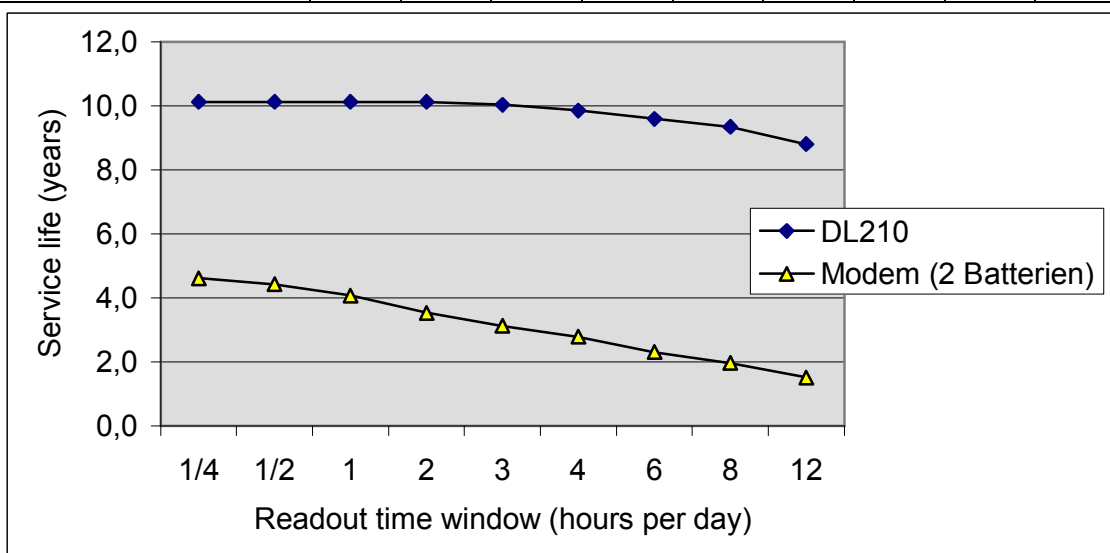

d) Sending SMS's

Readout time window 1 hour per month, additionally 30 minutes per month readout

SMS's per day	1	2	3	4	6	8	10	12	24
DL210	12.5	12.0	11.8	11.5	10.9	10.4	9.9	9.5	7.6
Modem (1 battery)	9.3	7.9	6.9	6.1	5.0	4.2	3.6	3.2	1.9
Modem (2 batteries)				12.2	10.0	8.4	7.2	6.4	3.7

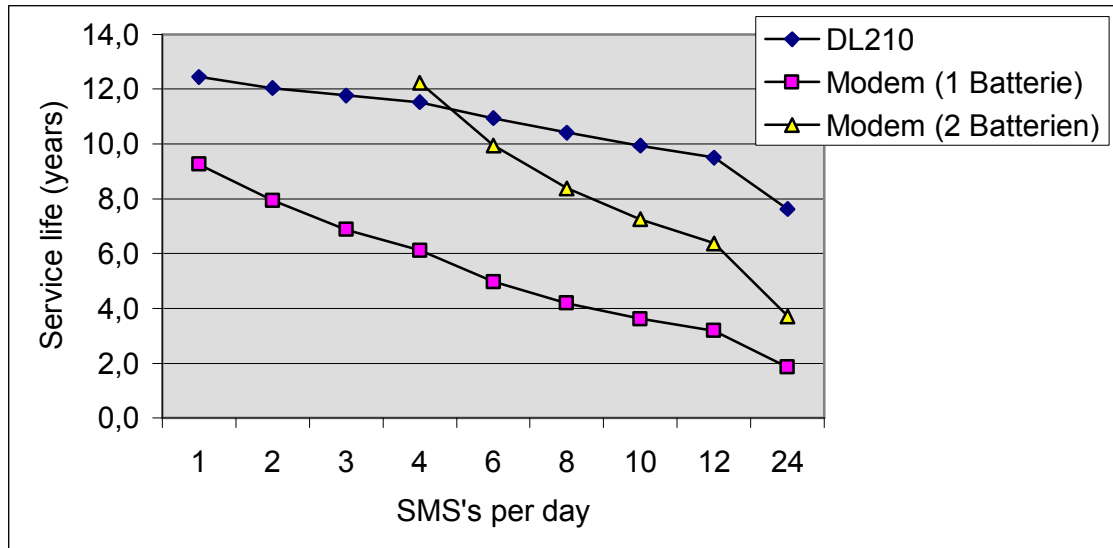

Appendix

Appendix A: Approvals

A-1 EC Declaration of Conformance for DL210

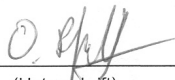
Konformitätserklärung	
gemäß der Richtlinie 89/336/EWG des Rates vom 03.Mai 1989 und den Änderungen 392L0031, 393L0068, übernommen durch 294A0103(52) über die elektromagnetische Verträglichkeit (EMV)	
Nr.	KCE118
Anbieter:	<u>Elster-Instromet Production GmbH</u>
Anschrift:	<u>Steinernstrasse 19-21</u> <u>D – 55252 Mainz-Kastel</u>
Produkt:	<u>Data Logger DL210</u>
Das oben beschriebene Produkt ist konform mit:	
Dokument-Nr	Titel
<u>EN 55011/22</u>	<u>Störfeldstärke</u>
<u>EN 55011/22</u>	<u>Störspannung</u>
<u>EN 61000-4-3</u>	<u>HF auf Gehäuse</u>
<u>EN 61000-4-6</u>	<u>HF auf Leitung</u>
<u>EN 61000-4-4</u>	<u>Schnelle Transienten (Burst)</u>
<u>EN 61000-4-5</u>	<u>Energiereiche Impulse (Surge)</u>
<u>EN 61000-4-2</u>	<u>Elektrostatistische Entladung</u>
Zusätzliche Angaben	
<u>Störaussendung „Klasse B“,</u>	
<u>Störfestigkeit nach Einstufung in „Kontinuierlicher nicht überwachter Betrieb“</u>	
<u>Mainz-Kastel, 21.12.2005</u>	
(Ort und Datum der Ausstellung)	
<u>O. Pfaff, Leiter Entwicklung Elektronik-Systeme</u>	
(Name, Funktion)	(Unterschrift)

Declaration of Conformance (Translation of original document)

according to the Directive 89/336/EEC of the Council of 3rd May 1989 and the changes 392L0031, 393L0068, incorporated through 294A0103(52) about the electromagnetic compatibility (EMC)

No. KCE118

Supplier: Elster-Instromet Production GmbH

Address: Steinernstrasse 19-21
D-55252 Mainz-Kastel

Product: Data Logger DL210

The product described above conforms to:

Document No.	Title
EN 55011/22	Interference field strength
EN 55011/22	Interference voltage
EN 61000-4-3	RF on the housing
EN 61000-4-6	RF on the cable
EN 61000-4-4	Fast transients (burst)
EN 61000-4-5	High energy pulses (surge)
EN 61000-4-2	Electrostatic discharge

Additional details

Interference emission "Class B",

Interference immunity according to classification in "Continuous non-supervised operation"

Mainz-Kastel, 21.12.2005

(Place and date of issue)

O. Pfaff, Development Manager for Electronic Systems

(Name, function)

(Signed)

Appendix B: Technical data

B-1 General data (mechanical)

Housing/construction	Wall-mounted housing, ABS plastic (Material durability: see Chap. 5.4)	
Dimensions (W x H x T)	approx. 120 x 120 x 90 mm	
Weight	approx. 720 g (with one modem battery)	
Protection	IP 64 according to EN60529	
Ambient temperature	DL210 basic unit:	-25 °C ... +60 °C
	with int. GSM modem (Wavecom):	-20 °C ... +55 °C
Relative humidity	≤ 93 % (non-condensing)	
Mounting	Using corrosion-protected screws where possible	

B-2 Power supply

a) Version for battery operation (standard):

Device battery	Lithium battery module, 3.6V, 16.5 Ah; Order no.: 73015774
Modem battery	Lithium battery module, 3.6V, 13 Ah; Order no.: 73017964

Optional:

2nd Modem battery	see above
Ext. voltage supply	9VDC – 24VDC; $P \geq 4.5$ Watt; conforms to CE e.g. plug-in power supply unit: Order no. 04275003

b) Version for mains supply:

Device battery	Lithium battery module, 3.6V 2.1 Ah; Order no.: 73016294
Ext. voltage supply	9 VDC, 4.5 W Plug-in power supply: Order no. 04275003

The min. service life of eight years for the basic device is guaranteed for the following **standard operating mode**:

Input 1	Pulse counting
Display active	1 h / month
Measurement cycle mode	900 s (updating every 15 minutes)
Interface active	30 min / month
Max. input frequency	$f = 1$ Hz
Ambient temperature	$T_A = 20$ °C

For the modem battery the service life can be estimated based on the table in Chap. 1.1.1.

B-3 Encoder, pulse and message inputs

2 signal inputs with common ground for reed contacts or transistor switches . No extraneous voltages or currents should be fed in.

Designation	I1... I2
Cable connection	Screw terminals; 0.5 ... 1.5 mm ² (solid); With flexible cable use wire-end sleeves.
Special features	each input can be parameterised and sealed separately, Input I2 can only be used as a signalling input
Max. cable length	max. 30 m depending on ambient conditions (EMC)

Nominal data

a) Use of input I1 as LF pulse or signalling input
and / or input I2 as signalling input

Open-circuit voltage	$U_0 \approx 3 \text{ V}$
Internal resistance	$R_i \approx 1 \text{ M}\Omega$
Short-circuit current	$I_s \approx 3 \text{ }\mu\text{A}$
Switching level "on"	$R_e < 1 \text{ M}\Omega$
Switching level "off"	$R_a > 1 \text{ M}\Omega$
Pulse duration	$t_e \geq 50 \text{ ms}$
Space duration	$t_a \geq 50 \text{ ms}$
Counting frequency	$f \leq 10 \text{ Hz}$

b) Use of input I1 as encoder input with Namur encoder

Open-circuit voltage	$U_0 \approx 8.2 \text{ V (7...9V)}$
Internal resistance	$R_i \approx 1 \text{ k}\Omega$
Short-circuit current	$I_s \approx 8 \text{ mA (7...9mA)}$
Switching level "on"	$I_e \leq 1.2 \text{ mA}$
Switching level "off"	$I_a \geq 2.1 \text{ mA}$
Baud rate	2400 Bd
Data format	7 data bits, even parity bit, 1 stop bit ("7e1")

c) Use of input I1 as encoder input with SCR encoder

Open-circuit voltage	$U_0 \approx 6 \text{ V (4.75...6.5V)}$
Internal resistance	$R_i \approx 1 \text{ k}\Omega$
Short-circuit current	$I_s \approx 6 \text{ mA (4.75...6.5mA)}$
Switching level "on"	$I_e > 3 \text{ mA}$
Switching level "off"	$I_a < 3 \text{ mA}$
Baud rate	300 Bd
Data format	7 data bits, even parity bit, 1 stop bit ("7e1")

B-4 Optical interface

Optical interface according to IEC 1107; bit-serial, asynchronous data transmission according to ISO 1177, half duplex. Support of **Data transmission mode "C"** (= Data read-out, programming and manufacturer-specific applications with autom. change of the baud rate).

Baud rate	300 Bd (initial baud rate); automatic changeover to 9600 Bd (adjustable)
Format	1 start, 7 data, 1 parity (even) and 1 stop bit.
Connection	Optical readout head on device front plate (automatic positioning / fixing by magnet) or in device via connector (X2)

B-5 Measurement uncertainty

Pulse mode:	± 1 pulse per measurement period
Encoder mode:	± 1 of the last transferred place of the encoder per measurement period
Momentary flow rate (Q_x)	< 5.0 % of measurement (display is not calibrated)

Appendix C: Data list

Below all values are listed which can be called via the keypad or interface and also changed depending on the status of the locks.

Via the interface all values must be accessed by means of the "address". On the device the address of the displayed value can be superimposed by pressing the key combination



Explanation of the addresses:

An address consists of an entity, colon and object. The entity and object should be considered as numbers (entity decimal, object hexadecimal) whose leading zeroes can be omitted. Example: The addresses "01:0100" and "1:100" have identical meanings.

Some objects have "sub-objects" whose "sub-object number" is appended to the address with an underscore "_" (e.g. "1:0140_1"). This sub-object number should be regarded as a figure after the decimal point: If it is "0", it can be omitted. Example: The addresses "1:100_0" and "1:100" have identical meanings.

Address	Short name	
1...16:0011		Available objects 010x...01Fx
1...16:0012		Available objects 020x...02Fx
1...16:0014		Available objects 040x...04Fx
1...16:0017		Available objects 070x...07Fx
1...16:0018		Available objects 080x...08Fx
1...16:001A		Available objects 0A0x...0AFx
1...16:001B		Available objects 0B0x...0BFx
1...16:001C		Available objects 0C0x...0CFx
1...16:001D		Available objects 0D0x...0DFx
1...16:0021		Available entities for objects 010x...01Fx
1...16:0022		Available entities for objects 020x...02Fx
1...16:0024		Available entities for objects 040x...04Fx
1...16:0027		Available entities for objects 070x...07Fx
1...16:0028		Available entities for objects 080x...08Fx
1...16:002C		Available entities for objects 0C0x...0CFx
1...16:002D		Available entities for objects 0D0x...0DFx
1:0030		Available entities for objects 0Axx
2:0030		Available entities for objects 0Bxx
3:0030		Available entities for objects 0Cxx
1:0040		Available attributes for working objects
2:0040		Available attributes for archive objects
1:0050		Number of access parties with own rights
2:0050		Maximum length of short designations
3:0050		Maximum length of units
1:0100	Stat	Total momentary status
2:0100	St.Sy	System - momentary status
1:0101	S.Reg	Total status register
2:0101	SR.Sy	System status register
1...8:0110	St.1...8	Momentary status 1..8
1...8:0111	SR.1...8	Status registers 1...8
1:0131	Save	Manual backup (save data)
1:0140		Date + time based on system day boundary
5:0140		Date + time based on day boundary for Input 1
6:0140		Date + time based on day boundary for Input 2
1:0140_1	year	Date based on system day boundary
5:0140_1	year	Date based on day boundary for Input 1
1:0140_2	month	Day and hour based on system day boundary
5:0140_2	month	Day and hour based on day boundary for Input 1

Address	Short name	
1:0140_3	daily	Hour/minute based on system day boundary
5:0140_3	daily	Hour / minute based on day boundary for Input 1
1:0140_4	week	Weekday...second based on system day boundary
5:0140_4	week	Weekday...second based on day boundary for Input 1
1:0140_5	month	Day...second based on system day boundary
5:0140_5	month	Day...second based on day boundary for Input 1
1:0140_6	hour	Minute...second according to system day boundary
5:0140_6	hour	Minute...second according to day boundary for Input 1
1:0141	DB.Sy	System day boundary (only hour)
5:0141	DB.I1	Day boundary Input 1 (only hour)
6:0141	DB.I2	Day boundary Input 2 (only hour)
1:0141_1	DB.Sy	System day boundary (represented as time)
5:0141_1	DB.I1	Day boundary Input 1 (represented as time)
1:0142		Number of days since 1.1.1970
5:0142		Number of days according to day boundary for Input 1
1:0143		Months counter (months since 01.01.1970)
5:0143		Month counter Input 2
1:0150		Backup time
3:0150		SMS cycle
4:0150	TimCS	Time of automatic clock setting by rem. data transmission
5:0150	Mp.I1	Measurement period Input 1
10:0150	CW1.S	Call window 1, begin
11:0150	CW2.S	Call window 2, begin
12:0150	L.MI1	Limit Input 1
13:0150	L.MI2	Limit Input 2
17:0150	MG.I1	Monthly cycle Input 1
21:0150	DB.I1	Daily cycle Input 1
23:0150	CW3.S	Call window 3 start
24:0150	CW4.S	Call window 4 start
1...24:0151		Event: Base 1 (for special applications)
1...24:0153		Event: Status pointer
1...24:0154		Source 1 (address) for derivation of the event
1...24:0155		Events designation
1...24:0156		Event counter for cyclical events
1:0157		Mode Event 1
3:0157		Mode Event 3
4:0157	MdCSy	Mode for clock setting by rem. data transmission
5:0157		Mode Event 5
6:0157		Mode Event 6
10:0157		Mode Event 10
11:0157		Mode Event 11
12:0157	MdMI1	Mode for monitoring I1
13:0157	MdMI2	Mode for monitoring I2
17:0157		Mode Event 17
18:0157		Mode Event 18
21:0157		Mode Event 21
22:0157		Mode Event 22
23:0157		Mode Event 23
24:0157		Mode Event 24
10:0158	CW1.E	Call window 1, end
11:0158	CW2.E	Call window 2, end
23:0158	CW3.E	Call window 3, end
24:0158	CW4.E	Call window 4, end
1...24:0159		Event: Base 2 (for special applications)
1...24:015A	MP.Re	Remaining period to expiry of cyclical event
1...24:015C		Source 2 (address) for generating the event
1:0160	V1Mp	Measurement period counter I1
2:0160	V1.Dy	Day counter I1
3:0160	V1Mp	Max. meas. per. count. I1 current month
4:0160	V1.Dy	Max. day counter I1 in curr. month
9:0160		Freely programmable capture value
10:0160		Freely programmable capture value

Address	Short name	
11:0160		Freely programmable capture value
12:0160		Freely programmable capture value
1:0161	V1M.L	Last measurement period value I1
2:0161	V1D.L	Last day consumption I1
3:0161	V1M.L	Max. meas. per. count. I1 last month
4:0161	V1D.L	Max. day counter I1, last month
9:0161		Freely programmable capture value
10:0161		Freely programmable capture value
11:0161		Freely programmable capture value
12:0161		Freely programmable capture value
1...12:0162		Mode for capture value 1..0.12
1...12:0163		Source (address) for generating the capture value
1...12:0164	Time	Time stamp for current capture value
1...12:0164_1	Date	Date stamp for current capture value
1...12:0164_2	Time	Time of current capture value
1...12:0165	Time	Time stamp for last capture value
1...12:0165_1	Date	Date of time stamp of last capture value
1...12:0165_2	Time	Time of time stamp of last capture value
1...12:0166		Mode for time stamp for capture value
1...12:0167		Event for starting the next capture value
1...12:0168	Stat	Time of current capture value
1...12:0169	Stat	Status for last capture value
1...12:016A		Mode for status of capture value
1...12:016C		Block number for current capture value
1...12:016D		Block number for last capture value
1...12:016E		Mode for block number for capture value
1...12:016F		Capture value designation
1:0170	St.PL	Calibration lock: Status / close
3:0170	St.SL	Supplier's lock: Status / close
4:0170	St.CL	Customer's lock: Status / close
5:0170	St.L5	Lock 5: Status / close
6:0170	St.L6	Lock 6: Status / close
7:0170	St.L7	Lock 7: Status / close
8:0170	St.PL	PTB logbook: lock: Status
3:0171	Cod.S	Supplier's combination, enter / change
4:0171	Cod.C	Customer's combination, enter / change
1:0180	SNo	Serial number
2:0180		Manufacturer number
3:0180		Station number
1:0181		Device designation
2:0181		Manufacturer's name
3:0181		Station name
1:0182		DLMS device number
1:018A_1	Mo.dl	Data book: Model
2:018A_1	InDat	Data book: Inspection date
3:018A_1	Contr	Data book: Contract no.
1:018A_2	Yman	Data book: Year of manufacture
1:018A_3	HW-V.	Data book: HW version
1:018A_4	Manuf	Data book: Manufacturer
2:018A_4	TeRig	Data book: Test rig
3:018A_6	Customer	Customer
2:0190	Vers	Software version number
2:0190_1	Vers	Version and variant no.
2:0191	Chk	Software checksum
2:0192	V.HW	Board version
2:0193	SN.HW	Board serial number
1:019A		File-name basic setting
2:019A		File-name country and language setting
3:019A		File-name customer setting
1:019B		Date manufactured, basic setting
2:019B		Date manufactured, country and language setting
3:019B		Date manufactured, customer setting

Address	Short name	
1:01A0	Aut.V	Time to changeover to standard display
2:01A0	Disp	Time before display switches off
1:01A1	Menu	Menu selection
1...15:01C0		Main menu headings
1...15:01C2	UsD1...15	Addresses for adjustable display values (user column, etc.)
1...15:01CB		Address for standard interrogation
1...15:01CC		Single capture value: Arising value
1...15:01CD		Single capture value: Last value
1...15:01CE		Single capture value: Mode
1...15:01CF		Single capture value: Source.
1...2:01D0		Designation of the data memory 1...2
1:01D1	ArEEP	Size of the archive range in memory 1
2:01D1	ArRAM	Size of the archive range in memory 2
1:01D4	SzEEP	Overall size of memory 1
2:01D4	SzRAM	Overall size of memory 2
1...7:01E0		Text for time units (seconds ... years; '7:1E1' = not used)
1...7:01E1		Short text for weekdays (Su...Sa)
1:01F0	MCyc	Measurement cycle
1:01F2		Display changeover target
1:01F3	Bat.C	Battery capacity
1:01F7		Display test
1:01F8	GBNo	Global block number for archive
1:01F9		Backup event
1:01FA	FlInfo	Information on error '8' in system status
1:01FA_1	FlInf1	Error text 1 for error '8' in system status
1:01FA_2	FlInf2	Error text 2 for error '8' in system status
1:01FA_3	FlInf3	Error text 3 for error '8' in system status
1:01FA_4	FlInf4	Error text 4 for error '8' in system status
1:01FB		Remain continually active with ext. power: yes / no
1:01FD		Event point for value acceptance for single capture values
1...2:0200	V1...2	Main counter input 1...2
1...2:0203	V1.A	Adjustable counter input 1...2
1...2:0207	Md.11...2	Mode for input 1...2
1...2:0208		Unit for input 1...2
1...2:0210	Q1...2	Flow on Input 1...2
1...2:0216		Format for flow input 1...2 (post-decimal places)
1...2:0218		Unit for flow input 1...2
1...2:021A	CuNo	Customer number, input 1...2
1...2:021B		Customer name, input 1...2
1...2:021C		Measuring point number, input 1...2
1...2:021D		Measuring point name, input 1...2
1...2:021E		Medium (accord. to "EDIS") for input 1...2
1...2:021F		Input designations
1:0220		Data book value for Input 1
1:0220_1	Mo.dl	Data book: Model of meter on Input 1
1:0220_2	Yman	Data book: Year of manufacture of meter on Input 1
1:0220_3	Manuf	Data book: Manufacturer of meter on Input 1
1:0220_4	Type	Data book: Type of meter on Input 1
1:0220_5	Pul.v	Data book: Pulse value of meter on Input 1
1:0221	Me.AA	Meas. point designation accord. to AA for input 1
1:0222	SNM	Serial no. of meter on Input 1
1:0223	Type	Type of gas meter on Input 1
1:0226		Raw pulse counter Input 1
1:0227		Frequency Input 1
1:0228	St.I1	Status on Input 1
1:022E	DS.Ca	DS-100 device number for main counter, input 1
1:022F	DS.Cb	DS-100 device number for LT counter, input 1
1...2:0230		Time pitch for SW debouncing in ms
1...2:0232		SW debounce: Period
1...2:0233		SW debounce: Pulse duration
1:023C	q.max	Maximum encoder flow
1:023D		Time window for flow calculation for encoder

Address	Short name	
1:023E		Minimum time for flow calculation for encoder
1:0240	Vo	Original meter reading
1:0241		Encoder name-plate
1:0241_1	Manuf	Manufacturer
1:0241_2	Med.	Medium
1:0241_3	SW.Z	Version
1:0241_4	Dat.Z	Date of manufacture
1:0242	SN.E	Encoder serial number
1:0243	PrpNo	Property number
1:0244	BdEnc	Encoder baud rate
1:0253	cp.l1	cp value Input 1
1:0400	Time	Date and time
1:0400_1		Seconds since 1970 (affected by daylight saving)
1:0400_2	Date	Date (affected by daylight saving)
1:0400_3	Time	Time (affected by daylight saving)
1:0402		Minutes counter (free of daylight saving)
1:0403		Hours counter (free of daylight saving)
2:0404	Bat.R	Remaining battery service life
2:0404_1	BatRS	Remaining battery service life in seconds
2:0405		Residual capacity of the battery
1:0407	MdTim	Summer time changeover: On / off
1:040F	TimeZ	Time zone
4:0410	VBatM	Modem battery voltage
4:0416		Data format for modem battery voltage
4:0418		Unit for modem battery voltage
4:041A		Event 1 for execution of measurement
4:041B		Event 2 for execution of measurement
1:0452	AdjTm	Adjustment value, clock (crystal inaccuracy)
1:0455		Clock adjustment mode
1:045A		Time adjustment - Reference value
1:04A0		Summer time, beginning
2:04A1		Battery warning limit (months)
1:04A8		Summer time, end
4:04A9		Warning limit for battery voltage
1:0705	Md.S1	Optical interface mode
2:0705	Md.S2	Internal interface mode
1:0707	DF.S1	Data format, optical interface
2:0707	DF.S2	Data format, internal interface
1:0708	BdIn1	Initial baud rate of optical interface
2:0708	Bd.S2	Baud rate, internal interface
1:0709	Bd.S1	Baud rate, optical interface
2:0709	BdId2	Baud-rate identification, int. interface
1...2:070E		Device address (blank = not used)
1...2:070F		Interface designation
1...2:0710		Character timeout (ms)
1...2:0711		Response timeout (ms)
1...2:0712		Inactivity timeout (s)
1...2:0713		Protocol timeout (s)
1:0715		(Not used)
2:0715		Timeout for GSM registration
1:0716		Type of addressing for standard interrogation
2:0716		Type of addressing for standard interrogation
2:0720	Num.T	Number of ringing tones before accepting call.
2:0721		Modem initialisation string
2:0722		Pointer to status "Time window 1"
2:0723		Pointer to status "Time window 2"
2:0724		Pointer to status "Time window 3"
2:0725		Pointer to status "Time window 4"
2:0727	CWTst	Test call window
2:0728	M.INI	Initialise modem
2:0729		Modem termination string
2:0731	Md.W	Dialling method mode

Address	Short name	
2:0732	NUM.A	Max. number of dialling attempts
2:0733		Max waiting time for carrier signal
2:0734_1	Send	Command: Send message now
2:0736	TNo.D	Own phone number
2:0738		Own modem type
2:0739		Phone no. of gateway SMS to e-mail
2:073A		Phone no. of gateway SMS to fax
2:0740	SP1.T	Recipient Type 1
2:0742	Resp1	Last response to Short Message 1
2:0743		SMS centre Access Number 1
2:074A	Resp2	Last response to Short Message 2
1...15:0750		Short message layouts 1...15: Value 1
1...15:0751		Short message layouts 1...15: Value 2
1...15:0752		Short message layouts 1...15: Value 3
1...15:0753		Short message layouts 1...15: Value 4
1...15:0754		Short message layouts 1...15: Value 5
1...15:0755		Short message layouts 1...15: Value 6
1...15:0756		Short message layouts 1...15: Value 7
1...15:0757		Short message layouts 1...15: Value 8
1...15:0758		Short message layouts 1...15: Value 9
1...15:0759		Short message layouts 1...15: Value 10
1...15:075A		Short message layouts 1...15: Value 11
1...15:075B		Short message layouts 1...15: Value 12
1...15:075C		Short message layouts 1...15: Value 13
1...15:075D		Short message layouts 1...15: Value 14
1...15:075E		Short message layouts 1...15: Value 15
1...15:0761		Name of short message layouts 1...15
2:0770		Command for reading PIN (SIM card)
2:0771		Command for setting PIN (SIM card)
2:0772	PIN	Entry of PIN for SIM card
2:0773		Command for auto-login
2:0774		Command for reading network operator
2:0775	GSM.N	GSM network operator
2:0776		Command for read'g recept. level (GSM)
2:0777	GSM.L	GSM reception level
2:077A	P.Sta	Status PIN of SIM card (GSM)
2:077B		Command string: Read registration info
2:077C	StM	Modem status GSM (code)
2:077C_1	StM	Modem status GSM (text)
2:0780	APN	GPRS Access Point Name ("APN")
2:0781	UName	GPRS SIM card user name ("ID")
2:0782	GP.Pw	GPRS SIM card password
2:0783	IPAdd	GPRS IP address
2:0784	Port	GPRS port address
2:0785		GPRS provider (for manual login)
2:0786	IPRem	GPRS IP addr. remote
2:0787		GPRS T_TxDelay
2:0788		GPRS MultiSlot
2:0789		GPRS T_Log
2:078A		GPRS T_Unlog
2:078B		GPRS T_Mod
2:078C	MAtt	GPRS M_Attach
2:078D	MSta	GPRS M_Start
2:078E	MLis	GPRS M_Listening
2:0790	MOpen	GPRS M_OpenSocket
2:0791	MClos	GPRS M_CloseSocket
2:0792	GP.St	GPRS Status
2:07D0	TNoCS	Telephone no. for time synchronisation
2:07D1	DevCS	Limit for time synchronisation
2:07D2	Ev.S	Event for time synchronisation
2:07D3	Sync	Command: Time synchronisation
2:07D4	CSync	Submenu: Time synchronisation

Address	Short name	
2:07D5	DF.CS	Data format for time synchronisation
1:0810	Add	Audit Trail: Address of the changed value
1:0811	a	Audit Trail: Old value
1:0812	n	Audit Trail: New value
1:0840	#1	Text for Message 1 in total status
2:0840	#1	Text for Message 1 in system status
1:0841	#2	Text for Message 2 in total status
2:0841	#2	Text for Message 2 in system status
1:0842	#3	Text for Message 3 in total status
2:0842	#3	Text for Message 3 in system status
1:0843	#4	Text for Message 4 in total status
2:0843	#4	Text for Message 4 in system status
1:0844	#5	Text for Message 5 in total status
2:0844	#5	Text for Message 5 in system status
1:0845	#6	Text for Message 6 in total status
2:0845	#6	Text for Message 6 in system status
1:0846	#7	Text for Message 7 in total status
2:0846	#7	Text for Message 7 in system status
1:0847	#8	Text for Message 8 in total status
2:0847	#8	Text for Message 8 in system status
1:0848	#9	Text for Message 9 in total status
2:0848	#9	Text for Message 9 in system status
1:0849	#10	Text for Message 10 in total status
2:0849	#10	Text for Message 10 in system status
1:084A	#11	Text for Message 11 in total status
2:084A	#11	Text for Message 11 in system status
1:084B	#12	Text for Message 12 in total status
2:084B	#12	Text for Message 12 in system status
1:084C	#13	Text for Message 13 in total status
2:084C	#13	Text for Message 13 in system status
1:084D	#14	Text for Message 14 in total status
2:084D	#14	Text for Message 14 in system status
1:084E	#15	Text for Message 15 in total status
2:084E	#15	Text for Message 15 in system status
1:084F	#16	Text for Message 16 in total status
2:084F	#16	Text for Message 16 in system status
1...8:0850	#1	Text for Message 1 in status 1...8
1...8:0851	#2	Text for Message 2 in status 1...8
1...8:0852	#3	Text for Message 3 in status 1...8
1...8:0853	#4	Text for Message 4 in status 1...8
1...8:0854	#5	Text for Message 5 in status 1...8
1...8:0855	#6	Text for Message 6 in status 1...8
1...8:0856	#7	Text for Message 7 in status 1...8
1...8:0857	#8	Text for Message 8 in status 1...8
1...8:0858	#9	Text for Message 9 in status 1...8
1...8:0859	#10	Text for Message 10 in status 1...8
1...8:085A	#11	Text for Message 11 in status 1...8
1...8:085B	#12	Text for Message 12 in status 1...8
1...8:085C	#13	Text for Message 13 in status 1...8
1...8:085D	#14	Text for Message 14 in status 1...8
1...8:085E	#15	Text for Message 15 in status 1...8
1...8:085F	#16	Text for Message 16 in status 1...8
1...6:0860		Texts for 'Mode status GSM' (77C_1)
1...15:0890		LIS200 address for OBIS code
1...15:0891		OBIS code
1:08AF		Status word according to Selma
1...12:08D0		Free user texts (each max. 62 characters)
1:08F9		Keypad simulation
1:08FA		Display content line 1
2:08FA		Display content line 2
1:08FD	Clr.A	Clear all measurement archives
2:08FF		Activate labelling of non-calibrated value

Address	Short name	
1...13:0A00		Memory no. in which the archive is located
1...13:0A01	ArSiz	Archive memory depth (no. of data records)
1...13:0A20	ABNo	Internal archive block number
1...13:0A21	Check	Checksum, archive data record (CRC)
1...13:0A22	Ev	Trigger event for last archive data record
1:0A30	ArMo1	Display of month archive I1
2:0A30	ArMP1	Display of measurement period archive I1
10:0A30	Logb.	Display of logbook
11:0A30	AudTr	Display of audit trail
12:0A30	PLogb	PTB logbook display
13:0A30	ArDy1	Display of day value archive I1
1...13:0A32		Archive data record type (for WinLIS, WinView)
1...13:0A33		Text for event 'Change of archive-relevant data'
1...13:0A35		Trigger event for determining the day boundary
2:0A50	FrMP1	Command 'Save data record' in meas. per. arch. I1
12:0A51		Stop PTB logbook
1...13:0A52	CIMo1...13	Clear archive
12:0A53		Time of last clearing of PTB logbook
1...13:0A60		Triggering event 1 for archive ...
1...13:0A61		Triggering event 2 for archive ...
1...13:0A62		Triggering event 3 for archive ...
1...13:0A63		Triggering event 4 for archive ...
1...13:0A64		Triggering event 5 for archive ...
1...13:0A65		Triggering event 6 for archive ...
1...13:0B02		Readout control: Code for readout time period - supplier
1...13:0B03		Readout control: Code for readout time period - customer
1...13:0B04		Readout control: Code for readout time period - maintenance
1...13:0B05		Readout control: Code for readout time period - network operator
1...13:0B12		Readout control: Bookmark position - supplier
1...13:0B13		Readout control: Bookmark position - customer
1...13:0B14		Readout control: Bookmark position - service
1...13:0B15		Readout control: Bookmark position - network operator
1...13:0B22		Readout control: Bookmark - supplier
1...13:0B23		Readout control: Bookmark - customer
1...13:0B24		Readout control: Bookmark - service
1...13:0B25		Readout control: Bookmark - network operator
1...13:0B32		Readout control: Note text - supplier
1...13:0B33		Readout control: Note text - customer
1...13:0B34		Readout control: Note text - maintenance
1...13:0B35		Readout control: Note text - network operator
1:0C00		1. Counter in month archive I1
2:0C00		1. Counter in measuring period archive I1
13:0C00		1. Counter in day value archive I1
1:0C01		2. counter in month archive I1
2:0C01		2. counter in measuring period archive I1
13:0C01		2. Counter in day value archive I1
13:0CF0		Measurement period of the day value archive
13:0CF1		Start of day of the day value archive
13:0CF2		DS-100 device no. for day value archive value 1
13:0CF3		DS-100 device no. for day value archive value 2
1...10:0D00		Event for sending the short message 1...10
1...10:0D01		Number of recipients for short message 1...10
1...10:0D02		Layout number of SM for short message 1...10
1...10:0D04		Recipient 1 for short message 1...10
1...10:0D05		Recipient 2 for short message 1...10
1...10:0D06		Type of delivery to recipient 1 for short message 1...10
1...10:0D07		Type of delivery to recipient 2 for short message 1...10
1...10:0D08		Result of SM to recipient 1 for short message 1...10
1...10:0D09		Result of SM to recipient 2 for short message 1...10
1...10:0D0A		Delay range for short message 1...10
1...3:0D10		Name of network provider for GSM network 1...3
1...3:0D11		Dial-up number for analogue trans. for GSM network 1...3

Address	Short name	
1...3:0D12		Data format for analogue modem for GSM network 1...3
1...3:0D13		Data format for GSM network 1...3
1...3:0D14		Baud rate for GSM network 1...3
1...3:0D15		Supplement to modem init. string for GSM network 1...3
1...5:0D20		Name of recipient for destination 1...5
1...5:0D21		Network provider for destination 1...5
1...5:0D22		Phone no. of recipient for destination 1...5
1...5:0D23		E-mail addr. for SMS-to-e-mail for destination 1...5
1...5:0D24		Message format for destination 1...5
1...5:0D25		SMS separator for destination 1...5
1...5:0D26		Sender identification for recipient (destination 1...5)

Appendix D: Index

A

Adjustable counter · 38
Alarm · 17, 63
 Ambient temperature · 121
Antenna options · 104
 Application as flow recording device · 49
Approvals · 12
 Archive entries, calling up · 50
 Archives · 44
 AS-200/S2 · 54, 55
Association Agreement · 41

B

Backup · 81
 Battery · 121
Battery replacement, modem battery · 114
Battery service life · 78, 109, 115
Baud rate · 85

C

Cable length · 122
 Cable routing · 105
 Cal.lock o. · 17, 81
Calibration inspection · 97
Calibration lock · 30
Calibration switch · 30
 Calling the Help · 18
 Changes archive · 44, 60
Changing values · 28
 Checksum · 78
 Clear archives · 81
 Clear counters · 81
 Clear PTB logbook · 58
 Clear status register · 57
 Clearing the status message · 68
 Clock adjustment value · 81
Closing the calibration switch · 98
 Consumption · 50
 Continuous display · 78
 Copyright · 3
 cp value · 111
 cp value signal input · 39
Customer lock · 31
Customer number · 40, 111
 Customer's combination · 80
 Customer's lock · 31, 34, 80

D

Data backup · 81
Data interface: · 12
 Data transmission, mode · 94
 Date · 77
 Day boundary · 40
 Day counter · 40

Day counter, last · 41
 Day value archive · 44
 Daylight saving · 77
 Display · 15, 16
 Display changeover · 78
 Display, flashing · 50
 dmail · 88
 DS-100 number · 52

E

EC Declaration of Conformance · 119
Encoder · 42, 122
Encoder data · 42
 Enter · 18
 Entry cancellation · 18
 Entry errors · 27
Entry function · 26
 Entry mode · 26
 Er.Ch – Checksum in archive · 45
 Event counter · 75
 Event data change · 76
 Event for triggering an SM · 93
 Event freeze · 76
Events in the DL210 · 69

F

Fitting the SIM card · 106
 Flow rate, momentary · 38
 Flow recording device · 51
Flow, momentary · 38
 Front panel · 15

G

GPRS · 14
 Group message · 65, 71
 GSM network operator · 83
 GSM reception level · 84

H

High flow display · 51
High flow display function · 46

I

IEC 1107 · 54
 Incorrect entries · 27
 Index · 124
 Individual message · 69
 Initial. values · 25
 Input list · 35, 36, 37
 Installation · 102
 Internal hinges · 105

K

Key function · 18, 19

L

Last response · 85
Limit of monitoring function · 38
List structure · 20
Liste, Zaehl-/Meldeeingang · 21
Logbook · 44, 57, 59
Log-in status · 84

M

Main counter · 37
Maintenance · 54, 112
Max. meas. period counter · 40
Maximum · 16
Maximum day counter · 41
Mean · 16
Measurement cycle · 78
Measurement period · 40, 111
Measurement period archive · 41, 44, 48
Measurement uncertainty · 123
Memory depth · 49
Message groups · 74
Message numbers, overview · 64
Meter no. · 111
Minimum · 16
Mode for monitoring · 39
Mode of signal input · 38
Mode SMS · 93
Mode, data transmission · 94
Modem battery · 80, 107
Modem operation · 87
Modem status · 84
Momentary status · 57, 58, 63
Monitoring · 38
Month archive · 41, 44, 46

N

Namur · 42
Network operator · 54, 83

O

Operating errors · 27
Operation under calibration · 97
Order number · 8
Own GSM network · 89

P

Parameter list · 124
Performance features · 12
PIN · 84
Power supply · 12
PROG symbol · 30
PTB logbook · 17, 30, 44, 58
PTB Regulations, Vol. 22 · 97
Putting into operation · 109

R

Readout time period · 56

Recalibration · 100

Reception level · 84
Reed contacts · 122
Remaining battery service life · 79
Report · 63
Restart · 82
Rights of values · 30

S

Safety instructions · 6, 105
SCR OBIS 05 · 43
SCR OBIS 95 · 42
Seal layout · 99
Sealing · 98
SEND · 86
Serial number · 78
Serial number of meter · 39
Setting customer-specific parameters · 109
Settings for modem operation · 109
Signal inputs · 122
SIM card · 84
SM · 88
SM, **content and form** · 89
SM, event list · 93
SM, message format · 92
SM, provider list · 92
SM, recipient list · 92
SM, separator · 93
SM, Sending mode · 89
SMS · 14
SMS content · 89
SMS function · 88
SMS separator · 90
SMS, mode · 93
SMS-to-e-mail · 88
SMS-to-fax · 88
Software · 13
Source for monitoring · 39
Standard operating mode · 121
STAT – Status in archive · 45
Status list · 57
Status messages · 66
Status register · 57, 58, 63
Submenus · 24
supplier's combination · 80
Supplier's lock · 31, 80
SW debounce · 41
Switching off the display · 78
System interface · 111
System list · 77
System message · 70

T

Technical data · 121
Temperature range · 80

Terminal layout · 108

Time · 77

Transistor switches · 122

Transmission attempts · 88

U

Unit for input · 111

Unit, input · 41

User list · 95

W

Warning · 17, 63

WinCOMS · 54, 56

WinPADS240 · 54, 56

WinVIEW · 111